

- 1
- 2
- 3
- 4
- 5
- 6
- 7
- 8
- 9
- 10
- 11
- 12
- 13
- 14

Single Components as Replacement Parts

Article number/Reference number	4R72	4R75=D-70	4R84	4R104
501Z16 Clamping Screw				▲
506G3=M5x8 Set Screw				▲
506G3=M8x12-V Grub Screw	▲	▲	▲	
506G3=M8x16 Set Screw				▲

▲ Minimum order quantity required

4R50 Pyramid Adapter with Threaded Connector

Used in combination with the 4R44=L Pyramid Receiver with Threaded Connector for individual length compensation and rotation adjustment in transtibial and transfemoral prostheses. This adjustment unit consisting of the 4R50 and 4R44=L Adapter can be used to connect e.g. to the 4R150 Harmony HD system.

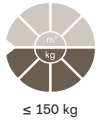

Article number	4R50
Material	Titanium
System height	-1 mm
Weight	70 g
Max. body weight	150 kg



647G185

4R44=L Pyramid Receiver with Threaded Connector

Used in combination with the 4R50 Pyramid Adapter with Threaded Connector for individual length compensation as well as rotation adjustment in transtibial and transfemoral prostheses. The adapter can be reduced in length. The combination of the 4R44=L with the 4R43 or 4R111=N Lamination Anchor creates a length-adjustable socket connector.



Article number	4R44=L
Material	Stainless steel
Min. system height	31 mm
Max. system height	91 mm
Weight	210 g
Max. body weight	150 kg



647G185

4R101 Sliding Adapter

The 4R101 Sliding Adapter is installed between the socket attachment block (5R1 or 5R6) and the socket adapter (e.g. 4R51). Independent repositioning in the frontal and sagittal plane is possible. The displacement can be read on the scale.



Article number	4R101
Material	Aluminum
System height	25 mm
Weight	205 g
Offset in m-l and a-p direction	+/- 11 mm
Max. body weight	100 kg



647H141



- In transtibial prostheses, the 4R101 Sliding Adapter is only suited for initial and/or interim use; in transfemoral prostheses, it is also suited for definitive use.

1

2

3

4

5

6

7

8

9

10

11

12

13

14

1



2

647G319



4R118 Adapter Plate

The adapter plate is used especially for permanent additional posterior placement of the knee joint (e.g. 3R90 and 3R92) to the prosthetic socket. It can only be used in combination with an adapter with four-hole connection (e.g. 5R1 and 5R2).



3

4

Article number	4R118
Material	Aluminum
System height	10 mm
Weight	75 g
Displacement	10 to 25 mm
Max. body weight	125 kg

5

Single Components as Replacement Parts

6

7

8

9

10

11

12

13

14

Article number	4R44=L	4R50	4R101	4R118
4Y212 Clamping Nut			▲	
501S41=M6x12 Countersunk Head Screw (Allen screw)				▲
501S44=M6x25 Oval Flange Head Screw (Allen screw)			▲	
501T61=M6x12 Cap Screw				▲
501T61=M6x25 Cap Screw				▲
501T61=M6x30 Cap Screw				▲
501Z2=M6x20 Cap Screw		▲		
506G3=M4x12 Set Screw			▲	
506G3=M8x12-V Grub Screw	▲			

▲ Minimum order quantity required

Lamination Anchor with Pyramid Adapter

The 4R100, 4R68 and 4R63 Lamination Anchors are intended for lamination in the transtibial socket.

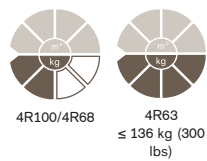

647H86 (4R100,4R63)
647H10 (4R68)

Article number	4R100	4R68	4R63
Material	Titanium	Aluminum	Stainless steel
System height	-8 mm	-7 mm	
Weight	55 g	70 g	95 g
Max. body weight	100 kg		136 kg

The 4R63=3 and 4R63=5.1 Lamination Anchors are intended for lamination in the transtibial socket.



Article number	4R63=5	4R63=5.1
Material	Stainless steel	
System height	-7 mm	
Weight	95 g	
Max. body weight	125 kg	

- ▶ 4R100, 4R63: 4X3 and 4X52 Lamination Dummies have to be used during laminating. They are enclosed with the lamination anchor.
- ▶ 4R68: The 4X3 Lamination Dummy have to be used for laminating. It is enclosed with the lamination anchor.

Lamination Anchor with Pyramid Adapter

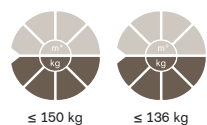

647H247

Article number	4R42	4R42=5
Material	Stainless steel	
System height	-5 mm	
Weight	130 g	125 g
Max. body weight	150 kg	136 kg

- ▶ The 4X3 Lamination Dummy should be used for laminating. It is enclosed with the lamination anchor.

1



2



3

647H247

4

5

4R43 Lamination Anchor with Threaded Connector

The 4R43 Lamination Anchor can be combined e.g. with the 4R44=L Pyramid Receiver with Threaded Connector as a length-adjustable socket connection, or with the 4R57=ST Rotation Adapter. In the latter case, the 4X46=ST Lamination Dummy has to be used for laminating. It must be ordered separately (see accessories Page 169).



Article number	4R43
Material	Stainless steel
System height	8 mm
Weight	95 g
Max. body weight	125 kg

- Use the 4X46 Lamination Dummy when laminating. It must be ordered separately (see accessories Page 158).

6



7



8

647H247

9

4R89 Lamination Anchor with Pyramid Adapter, rotatable



Article number	4R89
Material	Stainless steel
System height	-3 mm
Weight	180 g
Max. body weight	125 kg

- Use the 4X46 Lamination Dummy when laminating. It must be ordered separately (see accessories Page 158).

10



11



12

647H247

13

14

4R41 Lamination Anchor with Pyramid Receiver, rotatable



Article number	4R41
Material	Stainless steel
System height	39 mm
Weight	170 g
Max. body weight	125 kg

- Use the 4X46 Lamination Dummy when laminating. It must be ordered separately (see accessories Page 158).

4R111=N Lamination Anchor with Threaded Connector

The 4R111=N Lamination Anchor can be combined e.g. with the 4R44=L Pyramid Receiver with Threaded Connector as a length-adjustable socket connection, or with the 4R57=ST Rotation Adapter. In the latter case, the 4X46=ST Lamination Dummy has to be used for laminating. It must be ordered separately (see accessories Page 169).

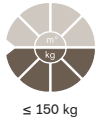

≤ 150 kg

Article number	4R111=N
Material	Stainless steel
System height	13 mm
Weight	80 g
Max. body weight	150 kg

- Use the 4X46 Lamination Dummy when laminating. It must be ordered separately (see accessories Page 158).



647G123

1

2

3

4

5

4R116 Lamination Anchor with Pyramid Adapter, rotatable



≤ 150 kg

Article number	4R116
Material	Stainless steel
System height	2 mm
Weight	165 g
Max. body weight	150 kg

- Use the 4X46 Lamination Dummy when laminating. It must be ordered separately (see accessories Page 158).



647G123



6

7

8

4R111 Lamination Anchor with Pyramid Receiver, rotatable



≤ 150 kg

Article number	4R111
Material	Stainless steel
System height	44 mm
Weight	155 g
Max. body weight	150 kg

- Use the 4X46 Lamination Dummy when laminating. It must be ordered separately (see accessories Page 158).



647G123



10

11

12

13

14

1



4X46 Lamination Dummy

for 4R41, 4R89, 4R111, 4R116, 4R119, 4R43, 4R111=N as well as 4WR95=1 and 4WR95=2 Lamination Anchor

Article number	4X46
-----------------------	-------------

2

3



4R119 Lamination Anchor with Pyramid Receiver and Angled Arm, rotatable

The 4R119 Lamination Anchor features an angled anchor arm, which is to be positioned posteriorly. This allows the adapter to be positioned easily for optimised prosthesis alignment (note the socket position and/or the flexion angle).



≤ 150 kg

Article number	4R119
Material	Stainless steel
System height	44 mm
Weight	165 g
Max. body weight	150 kg

5

6

- Only suitable for use in transfemoral prostheses.

Use the 4X46 Lamination Dummy when laminating. It must be ordered separately. See Page 158

7

8

The 4R87 is available as an individual component.

9



4R87 Pyramid Adapter with Threaded Connector

Article number	4R87
Material	Stainless steel
System height	-11 mm
Weight	85 g

10

11

The 4R44 is available as an individual component.

12



4R44=N Pyramid Receiver with Threaded Connector

Article number	4R44=N
Material	Stainless steel
System height	31 mm
Weight	75 g

13

14

Single Components as Replacement Parts

Article number	4R41	4R43	4R89	4R111	4R111=N	4R116	4R119
4R43 Lamination Anchor with Threaded Connector	■		■				
4R44=N Pyramid Receiver with Threaded Connector	■			■			■
4R87 Pyramid Adapter with Threaded Connector			■			■	
4R111=N Lamination Anchor with Threaded Connector				■		■	
501Z2=M5x22 Cap Screw							▲
501Z2=M5x30 Cap Screw	▲	▲	▲				
501Z2=M6x22 Cap Screw				▲	▲	▲	
506G3=M8x12-V Grub Screw	▲			▲		▲	▲
507U16=5.2-Nicro Rounded Washer							▲

▲ Minimum order quantity required ■ Can be ordered individually

1

2

3

4

5

6

7

8

9

10

11

12

13

14

1
2
3
4
5
6
7
8
9
10
11
12
13
14



647H31

Socket Adapter with Pyramid Adapter

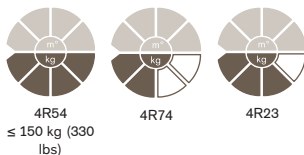

Article number	4R54	4R54=5	4R74	4R23
Material	Titanium		Aluminum	Stainless steel
System height	-11 mm	-7 mm		-11 mm
Weight	50 g		55 g	85 g
Max. body weight	150 kg	136 kg	100 kg	125 kg



647H31



4R77 Socket Adapter with Pyramid Adapter, rotatable

The pyramid adapter of the 4R77 Socket Adapter has a 9.5 mm bore hole. With corresponding positioning of the adapter, the bore hole permits a combination with the 5R2 Lamination Disc and the 6A30=10 or 6A30=20 Shuttle Lock.



Article number	4R77
Material	Titanium
System height	-9 mm
Weight	70 g
Max. body weight	150 kg



647H31



4R73=D



4R73=A

4R73 Socket Adapter with Pyramid Adapter, eccentric

Thanks to the eccentric arrangement of the pyramid adapter, the 4R73=A and 4R73=D Adapters permit sliding adjustment of the prosthetic socket in various planes.

The 4R73=A permits sliding adjustment in the sagittal and frontal plane. The arrangement of its pyramid adapter is axial-eccentric.

The 4R73=D permits a 45° combination in the sagittal and frontal plane. The arrangement of its pyramid adapter is diagonal-eccentric.



Article number	4R73=A	4R73=A-5.1	4R73=D
Material	Titanium		
System height	-11 mm	-10 mm	-11 mm
Weight	60 g		
Pyramid adapter alignment	Axially offset by 7 mm		Diagonally offset by 5 mm
Max. body weight	150 kg		

Socket Adapter with Pyramid Receiver

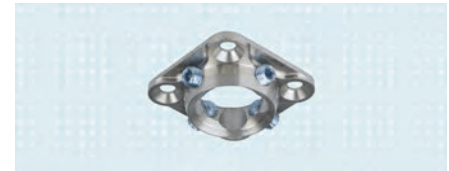
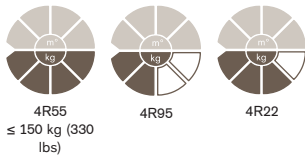

647G382

Article number	4R55	4R95	4R22
Material	Titanium	Aluminum	Stainless steel
System height	33 mm		
Weight	50 g		85 g
Max. body weight	150 kg	100 kg	125 kg

Socket Adapter with Pyramid Receiver, rotatable

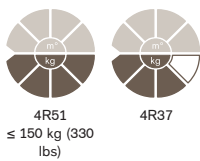

647G382

Article number	4R51	4R37
Material	Titanium	Stainless steel
System height	36 mm	
Weight	80 g	140 g
Max. body weight	150 kg	125 kg

Single Components as Replacement Parts

Article number	4R22	4R37	4R51	4R55	4R77	4R95
4Y19 Pressure Plate		▲	▲		▲	
506G3=M8x12-V Grub Screw	▲	▲	▲	▲		
506G3=M8x14 Set Screw						▲

▲ Minimum order quantity required

1
2
3
4
5
6
7
8
9
10
11
12
13
14



647G92
647G183 (5R1=6-H)

5R1 Socket Attachment Block for Lamination Technique

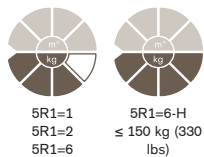

Article number	5R1=1	5R1=2	5R1=6	5R1=6-H
Wood connection diameter	147 mm	120 mm		
Material	Wood			
System height			30 mm	33 mm
Min. system height	46 mm			
Max. system height	64 mm			
Weight	445 g	355 g	155 g	240 g
Max. body weight	125 kg			150 kg

- The 4X6 Lamination Dummy has to be used for laminating. It is included with the socket attachment blocks.

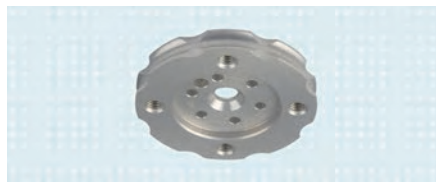

647G179

5R2 Lamination Disc

The 5R2 Lamination Disc can be combined with various Ottobock socket adapters as well as the 6A30=20 Shuttle Lock system.



Article number	5R2
Material	Aluminum
System height	9 mm
Weight	70 g
Max. body weight	150 kg

- The 4X86 Lamination Dummy has to be used for laminating. It is enclosed with the lamination disc.

6A94=3 Socket Mounting Plate

Article number	6A94=3
Colour	solid black

5R2=C Socket Attachment

The 5R2=C Socket Attachment is made of carbon and therefore particularly well suited for use in innovative carbon sockets. Since the carbon socket material and the carbon socket attachment have the same expansion properties, an excellent form and material fit between the socket and the socket attachment is achieved when the socket is fabricated.

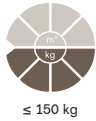

Article number	5R2=C
Material	Carbon
System height	10 mm
Weight	50 g
Max. body weight	150 kg

- 616B10=5 Carbon Fibre Woven Prepreg is particularly well suited for the fabrication of a thin-walled, high-strength and lightweight socket.



1

2

3

4

5

5R6 Socket Attachment for Thermoplastic Socket

The 5R6 Socket Attachment is available for three residual limb circumferences. It serves to provide a detachable connection for thermoplastic sockets with the modular system.

6B3 Halmstad Interim Transtibial Prosthesis Kit:

the 5R6 Socket Attachment Block and the distal modular component have to be ordered separately for finishing the prosthesis.



Article number	5R6=1	5R6=2	5R6=3
Material	Aluminium		
for	6B3=1	6B3=2	
Residual limb end circumference	~400 mm	~320 mm	~250 mm
System height	4 mm		
Weight	160 g	135 g	115 g
Max. body weight	100 kg		

- The 5Y14 Tool is required to create the proper distal shape. It must be ordered separately (see accessories Page 163).



647H4

6

7

8

9

10

Accessories for 5R6

5Y14 Tool

This tool facilitates creating the proper distal shape.

Article number	5Y14=1	5Y14=2	5Y14=3
for	5R6=1	5R6=2	5R6=3



647H4

11

12

13

14

Single Components as Replacement Parts

Article number/Reference number	4R108	4R109	5R1	5R2	5R6
501S41=M6x12 Countersunk Head Screw (Allen screw)				▲	
501S41=M6x16 Countersunk Head Screw (Allen screw)				▲	
501S41=M6x25 Countersunk Head Screw (Allen screw)			▲		
501S41=M6x30 Countersunk Head Screw (Allen screw)					▲
501S41=M10x20 Countersunk Head Screw (Allen screw)	▲				
501S74=3.5x9.5 Sheet Metal Screw				▲	
501Z2=M6x22 Cap Screw	▲				
501Z10 Oval Countersunk Head Screw		▲			
506S1=5x16 Clamping Sleeve	▲	▲			

▲ Minimum order quantity required

Modular Transtibial Sets

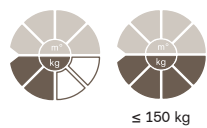

Article number	2R120	2R121	2R102
Diameter	30 mm		34 mm
Material	Titanium		
Consisting of	4R52 Tube Clamp Adapter 2R37 Tube Adapter	4R100 Lamination Anchor with Pyramid Adapter 4R52 Tube Clamp Adapter 2R37 Tube Adapter	4R82 Tube Clamp Adapter 2R57 Tube Adapter
Max. body weight	100 kg		150 kg

• Technical data and information for the individual components of the set are found under the respective components.

Modular Transtibial and Transfemoral Sets

1
2
3
4
5
6
7
8
9
10
11
12
13
14



Article number	2R105	2R122	4R201
Diameter	30 mm		
Material	Aluminum		Aluminum, Stainless steel
Consisting of	4R69 Tube Clamp Adapter 2R50 Tube Adapter	4R68 Lamination Anchor with Pyramid Adapter 4R69 Tube Clamp Adapter 2R50 Tube Adapter	4R37 Socket Adapter with Pyramid Receiver, rotatable 3R40 Modular Lightweight Single Axis Knee Joint with Lock 2R49 Tube Adapter
Max. body weight	100 kg		

Technical data and information for the individual components of the set are found under the respective components.

Modular Transtibial Sets



Article number	2R123	2R124	2R125=M8	2R125=M10	2R103
Diameter	30 mm				34 mm
Material	Stainless steel				
Consisting of	4R21 Tube Clamp Adapter 2R2 Tube Adapter	4R63 Lamination Anchor with Pyramid Adapter 4R21 Tube Clamp Adapter 2R2 Tube Adapter	4R63 Lamination Anchor with Pyramid Adapter 4R21 Tube Clamp Adapter 2R2 Tube Adapter 2R8=M8 Foot adapter with Screw Connection	4R63 Lamination Anchor with Pyramid Adapter 4R21 Tube Clamp Adapter 2R2 Tube Adapter 2R8=M10 Foot adapter with Screw Connection	4R91 Tube Clamp Adapter 2R76 Tube Adapter
Max. body weight	100 kg				150 kg

► Technical data and information for the individual components of the set are found under the respective components.

1
2
3
4
5
6
7
8
9
10
11
12
13
14



647G258

Rotation Adapter

Through incorporation of the rotation adapter above the knee joint, the lower leg may be rotated medially or laterally relative to the socket with the knee flexed.

For the amputee, this mainly translates into enhanced safety. The prosthesis can be swung to the side while driving. This minimises the risk of the prosthetic foot becoming stuck in the area of the pedals. The pedals can be operated using the other leg with no restrictions. In addition, this function allows the amputee to sit in a more comfortable and relaxed position behind the wheel, improving the focus on driving.

Furthermore, the rotation adapter means enhanced comfort for the amputee. It makes everyday activities such as putting on shoes and changing socks easier and allows the amputee to sit comfortably. The sitting position can be varied up to sitting cross-legged. The rotating mechanism is activated through pressing of the release button and is locked automatically.

There are two available versions which have the same function, but differ in terms of the proximal connection:

- Rotation adapter with pyramid adapter and pyramid receiver: the 4R57 Rotation Adapter is equipped with a proximal pyramid adapter.
- Rotation adapter with threaded connector and pyramid receiver: the 4R57=ST Rotation Adapter is equipped with a proximal thread. This allows for particularly space-saving integration of the adapter which can be screwed into the 4R111=N Lamination Anchor or the 4R43 Lamination Anchor.



≤ 150 kg



Article number	4R57	4R57=ST
Material	Stainless steel	
Proximal connection	Pyramid Adapter	Thread
Distal connection	Pyramid Receiver	
System height	22 mm	42 mm
Weight	170 g	185 g
Rotation	max. 360° (without foam cover)	
Max. body weight	150 kg	

- In order for the 4R57=ST Rotation Adapter to be able to be screwed properly into the lamination anchor, the 4X46=ST Lamination Dummy must be used for laminating. It must be ordered separately (see accessories Page 169).
- The 4R57 cannot be combined with the 2R49, 2R50 or 4R95.

Accessories

4X46=ST Lamination Dummy

Article number	4X46=ST
for	4R57=ST Rotation Adapter



Single Components as Replacement Parts

Article number	4R57	4R57=ST
4X69=1 Release Button Cover, grey	■	■
4X69=7 Release Button Cover, black	■	■
506G3=M8x12 Grub Screw	▲	▲

▲ Minimum order quantity required ■ Can be ordered individually

1

2

3

4

5

6

7

8

9

10

11

12

13

14

1
2
3
4
5
6
7
8
9
10
11
12
13
14

Torsion Adapter

Torsion adapters offer significant advantages for amputees, regardless of the amputation level. The socket holds the residual limb in place and therefore prevents rotation and torsion movements. Ottobock torsion adapters can compensate for this lack of mobility. This pays off during activities in confined spaces at work or home (e.g. the kitchen), where more mobility translates into enhanced safety for the amputee while performing his/her activities. For leisure activities, the torsion adapters also provide a solid basis for more mobility and comfort, for example while playing golf or tennis. Torsion adapters also help minimise shear forces in the area of the residual limb, which can otherwise result in painful shifting of soft tissues under stress. The torsion adapters serve to harmonise the gait pattern and improve wearer comfort, thereby reducing compensating movements and helping to prevent subsequent problems.



647G23

4R85 Torsion Adapter

Torsion adapter with pyramid receiver and Ø 30 mm tube connection.



Article number	4R85
Mobility grade	1 - 4
Diameter	30 mm
Material	Stainless steel
System height	68 mm
Weight	350 g
Rotation angle limitation by stops	+/- 20°
Stop strength	~ 100 Nm
Torsion moment of spring elasticity	7 Nm to max. 19 Nm
Max. body weight	100 kg

- When the 4R85 is used with the 3R15 and 3R49 Knee Joint with Friction Brake, the longer extension assist pulley included with the torsion adapter must be used.

4R86 Torsion Adapter

Torsion adapter with pyramid receiver and Ø 34 mm tube connection.



Article number	4R86
Mobility grade	1 - 4
Diameter	34 mm
Material	Titanium
System height	68 mm
Weight	340 g
Rotation angle limitation by stops	+/- 20°
Stop strength	~ 100 Nm
Torsion moment of spring elasticity	7 Nm to max. 19 Nm
Max. body weight	110 kg



 647G23

4R40 Torsion Adapter

The adapter has a proximal screw plate and distal pyramid receiver.



Article number	4R40
Mobility grade	1 - 4
Material	Stainless steel
System height	58 mm
Weight	340 g
Rotation angle limitation by stops	+/- 20°
Stop strength	~ 100 Nm
Torsion moment of spring elasticity	7 Nm to max. 19 Nm
Max. body weight	125 kg



 647G23

4R39 Torsion Adapter

Torsion adapter with Ø 30 mm tube and pyramid receiver.



Article number	4R39
Mobility grade	1 - 4
Diameter	30 mm
Material	Stainless steel
Min. system height	113 mm
Max. system height	476 mm
Weight	500 g
Rotation angle limitation by stops	+/- 20°
Stop strength	~ 100 Nm
Torsion moment of spring elasticity	7 Nm to max. 19 Nm
Max. body weight	125 kg



 647G23

- 1
- 2
- 3
- 4
- 5
- 6
- 7
- 8
- 9
- 10
- 11
- 12
- 13
- 14

Single Components as Replacement Parts

Article number	4R39	4R40	4R85	4R86
4D4 Single Component Pack			●	●
506G3=M8x12 Grub Screw	▲	▲	▲	▲

▲ Minimum order quantity required ● Single Component Pack

	1
	2
	3
	4
	5
	6
	7
	8
	9
	10
	11
	12
	13
	14

1
2
3
4
5
6
7
8
9
10
11
12
13
14



646A196=D 647H441

DeltaTwist

With the loss of the foot and part of the leg, the amputee has lost important proprioceptors and muscle groups which, through their interplay, ensure a harmonious gait pattern under physiological conditions. The DeltaTwist shock absorber, which also features a torsion function, is able to compensate for this loss to a certain degree. Its shock absorbing function and torsion function provide more safety, mobility and comfort. With its integration into the prosthesis, a more symmetrical gait pattern can be achieved. Instabilities can be eliminated and compensating movements are reduced. It relieves the locomotor system and residual limb.

Both shock absorption and the torsion function can be adjusted individually and independently by means of various elastomer components of different durometers. This allows the specific movement pattern of every amputee as well as biomechanical insights to be taken into account.

When needed, interior or exterior torsion can also be suppressed using the rotation locking segment (see accessories).

The DeltaTwist can be used for transfemoral as well as transtibial prostheses.



Article number	4R120	4R121=30	4R121=34
Mobility grade	2 - 4		
Outside Ø	47 mm		
Material	Aluminum		
Proximal connection	Tube clamp Ø 30 mm	Tube Ø 30 mm	Tube Ø 34 mm
Distal connection	Pyramid Receiver		
System height	117 mm		
Min. system height		117 mm	174 mm
Max. system height		553 mm	578 mm
Weight	~ 340 g	~ 530* g	~ 585* g
max. torsion inner/outer	± 20 °		
max. dampening	~ 8 mm		
Max. body weight	100 kg		125 kg

* After maximum shortening, the weight of the 4R121=30 is 325 g and the 4R121=34 is 355 g.

Indications:

- Unnatural, asymmetrical gait pattern in terms of the rotation in transversal plane (around the body's longitudinal axis)
- Overloading of the residual limb and locomotor system due to impact load and shear forces
- Significant sensibility against impact loads such as formation of oedema on the residual limb
- Pronounced dynamic gait patterns
- Frequent torsion stress (rotational movements) at work and during leisure activities

- The DeltaTwist models are delivered as a set.
The scope of delivery includes:



Sample Scope of Delivery 4R120

- 1 **1 DeltaTwist** shock absorber equipped with:
 - **1 Elastomer Bar** durometer medium (medium)
 - **2 Elastomer Plates** durometer medium (yellow)
- 2 **1 Elastomer Bar** durometer soft (red)
- 3 **1 Elastomer Bar** durometer hard (green)
- 4 **2 Elastomer Plates** durometer soft (red)
- 5 **2 Elastomer Plates** durometer hard (green)
- 6 **1 Combination Wrench** (mounting aid)
- 7 **1 Tube Special Grease**

Instructions for Use

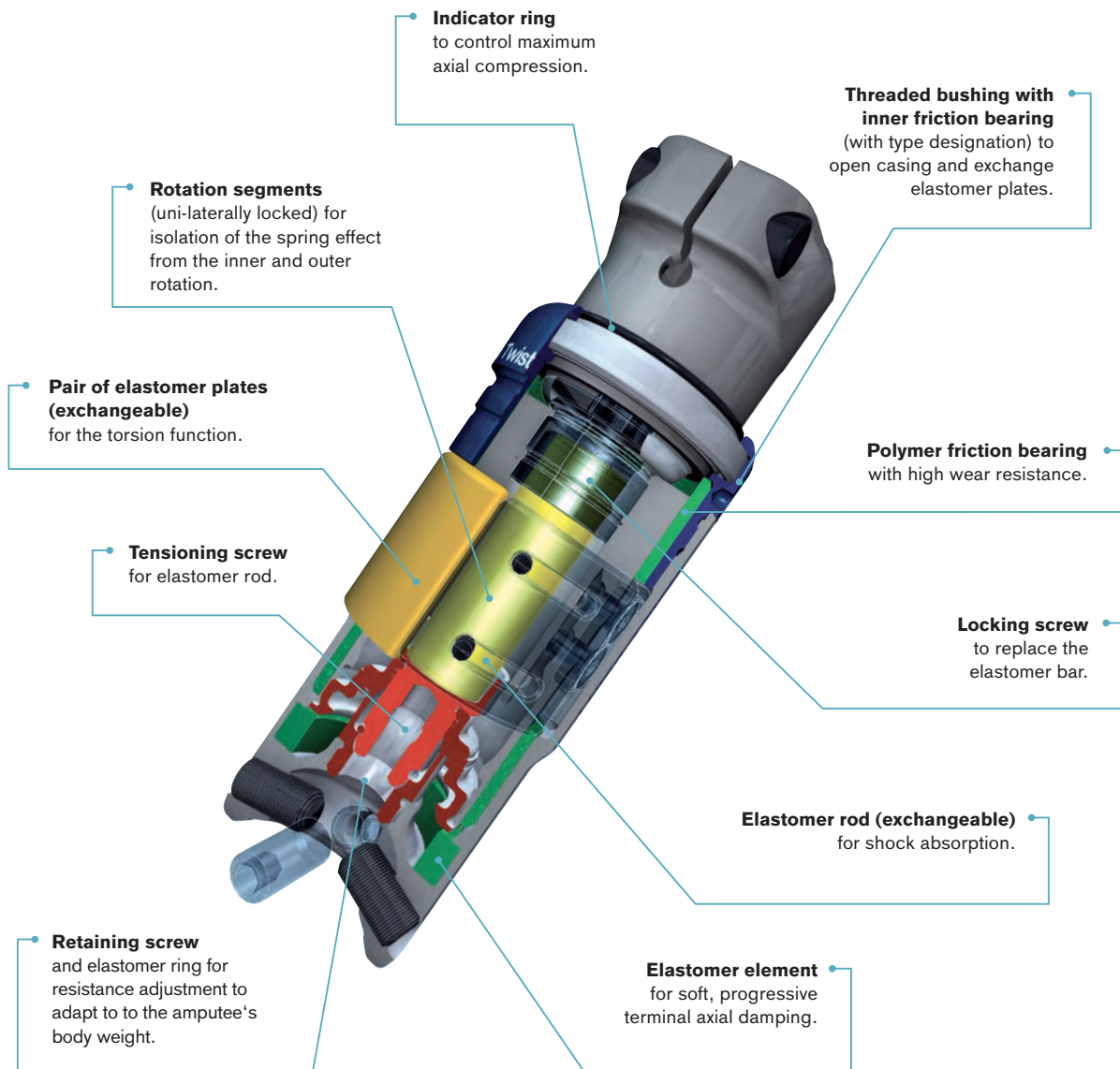

1
2
3
4
5
6
7
8
9
10
11
12
13
14

1
2
3
4
5
6
7
8
9
10
11
12
13
14

Accessories

Article number	4R120	4R121=30	4R121=34
709H5=4 Rotation Locking Plate, extra hard	■	■	■

■ Can be ordered individually

Socket wrench consisting of:

Article number	4R121=30	4R121=34
709H7 Socket Nut 1/2" hexagon SW11	■	■
709H8 Socket Nut Extension 1/ 2", length 575 mm	■	■
709H9 T-Handle 1/2"	■	■

■ Can be ordered individually

Single Components as Replacement Parts

Article number	4R120	4R121=30	4R121=34
633F30 Special Grease (Tube)	■	■	■
709H4 Combination Wrench	■	■	■
709H5=1 Elastomer Plate, hardness: soft	■	■	■
709H5=2 Elastomer Plate, hardness: medium	■	■	■
709H5=3 Elastomer Plate, hardness: hard	■	■	■
709H6=1 Elastomer Bar, hardness: soft	■	■	■
709H6=2 Elastomer Bar, hardness: medium	■	■	■
709H6=3 Elastomer Bar, hardness: hard	■	■	■

■ Can be ordered individually

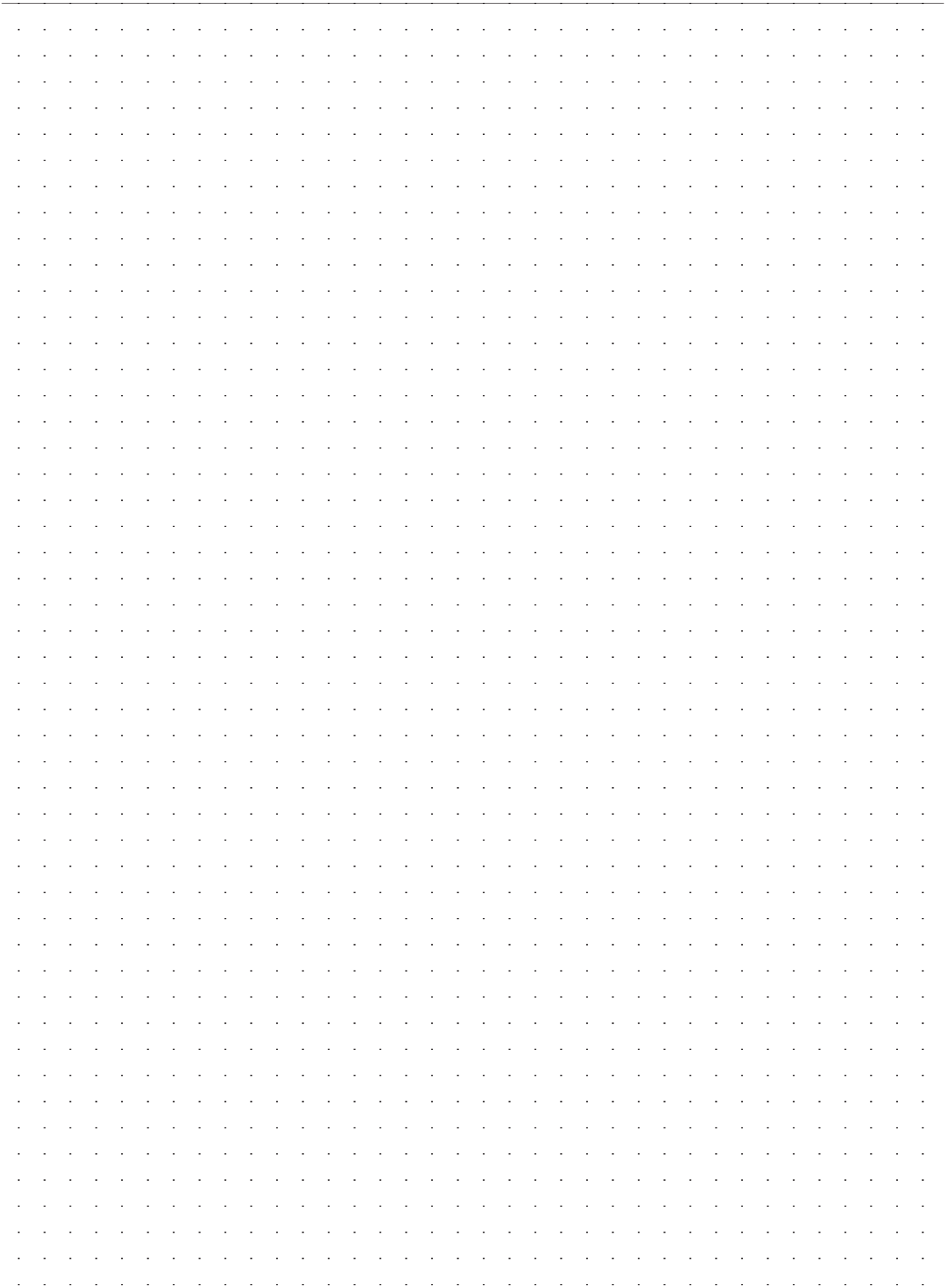

1
2
3
4
5
6
7
8
9
10
11
12
13
14

1

2

3

4

5

6

7

8

9

10

11

12

13

14



Modular Knee Joints

The function of modular knee joints is of special importance for the prosthetic fitting. During the stance phase, knee stability is the most important aspect; the joint must not buckle at heel strike. During the swing phase, the motion of the shin section of the prosthesis must be controlled.

For mechanical knee components, the technical possibilities to achieve stance phase control range from a locked joint, especially for geriatric fittings, to weight-dependent friction control or a polycentric design – also with elastic stance phase flexion, e.g. in the 3R60. Hydraulic stance phase control is made possible with components such as the 3R80.

With electronic knee joints in the C-Leg product line, the hydraulics to secure the stance phase are controlled by a microprocessor.

Swing phase control is realised, for example, by means of flexible extension assists that are independent of the walking speed. On the other hand, the pneumatic and hydraulic damping elements create speed-dependent motion resistance and adjust themselves to the gait rhythm. Based on measured data, the C-Leg adapts to the current walking situation in real time.

The selection of a suitable mechanically or electronically controlled knee joint depends on a variety of factors such as the amputation level, condition of the residual limb, overall physical condition, weight and environment surrounding the patient. Older prosthesis wearers with reduced mobility require a high degree of knee stability. Here, easy handling and wearer comfort are more important than dynamic aspects.

The knee joint and prosthetic foot must be regarded as a functional unit, so that these components should be coordinated (see knee-foot combination, page 32).

1

2

3

4

5

6

7

8

9

10

11

12

13

14

1

2

3

4

5

6

7

8

9

10

11

12

13

14

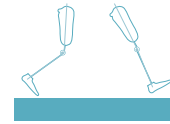
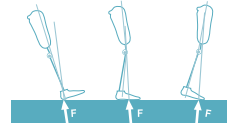
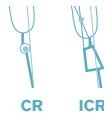
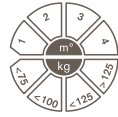

Joint	MOBIS				Max. body weight				Design		Stance phase control through alignment and:				Swing phase control		
	1	2	3	4	≤ 75 kg (165 lbs)	≤ 100 kg (220 lbs)	≤ 125 kg (275 lbs)	≤ 150 kg (330 lbs)	mono-centric	poly-centric	Locking unit	Wheel lock	Polycentric structure	Special features	Mechanics	Pneumatics	Hydraulics
3R40	■				■	■			■		■						
3R41					■	■			■		■				■		
3R33/17							■	■	■		■				■		
3R49/15		■							■			■			■		
3R36/20									■			■			■		
3R93		■					■		■		■				■		
3R90		■							■			■			■		
3R92			■						■			■				■	
3R106/=ST			■						■				■			■	
3R60/=ST		■							■				■	EBS			■
3R60-PRO/=ST		■							■				■	progressive EBS			■
3C96-1/ 3C86-1		■							■				■	Hydraulics + electronics			■
3R78		■							■				■		■		
3B1/=ST		■		■					■				■	Hydraulics + electronics Rotation hydraulics		■	electronically controlled Rotation hydraulics
3R80		■		■					■				■			■	
3R55		■							■				■				■
3C98-2/ 3C88-1		■							■				■	Hydraulics + electronics		■	electronically controlled
3R95/=1		■							■				■				■
3R32/23	■								■		■						
3R30/21									■		■				■		
3R106=KD		■		■					■				■			■	
3R60=KD		■		■					■				■	EBS			■
3R60-PRO=KD		■		■					■				■	progressive EBS			■
3C86-1		■		■					■				■	Hydraulics + electronics		■	electronically controlled
3B1=ST		■		■					■				■	Hydraulics + electronics		■	electronically controlled
3R46		■							■				■				■
3C88-1		■							■				■	Hydraulics + electronics		■	electronically controlled
3R36/20	■								■				■		■		
3R106=HD		■		■					■				■			■	
3R60=HD		■		■					■				■	EBS			■
3R60-PRO=HD		■		■					■				■	progressive EBS			■
3C96-1		■							■				■	Hydraulics + electronics			■
3B1		■		■					■				■	Hydraulics + electronics		■	electronically controlled
3C98-2		■		■					■				■	Hydraulics + electronics		■	electronically controlled

3R41 Ottobock Modular Monocentric Locking Knee Joint

With the new 3R41, the latest in synthetic material technology is conquering lower limb prosthetics.

The next generation of the traditional locking knee joint offers additional advantages, is moisture-resistant, lightweight and especially resistant to wear. Transfemoral amputees with very low activity levels and the highest need for safety benefit from the easy handling of the innovative release mechanism in particular; it can even be triggered under partial load.

The lower joint section is equipped with a \varnothing 30 mm tube clamp.



Article number	3R41
Mobility grade	1
Material	Plastic
Proximal connection	Pyramid adapter (movable)
Distal connection	Tube clamp \varnothing 30 mm
Knee flexion angle	150 °
System height	24 mm
proximal system height to alignment reference point	12 mm
distal system height to alignment reference point	12 mm
Weight	385 g
Max. body weight	100 kg

- Use the 3S107 Foam Cover for the 3R41.
- For accessory see the pages 184, 202

Functions and Benefits

The innovative locking mechanism automatically secures the joint at full extension and the user can hear and feel the lock latch engage. The joint can be unlocked using the pull cable or by pressing the lock latch (patella). In developing this knee joint, special attention was paid to the balanced relationship between the unlocking force and the load on the prosthesis in order to make handling even safer.

Through the use of plastics, the joint is particularly lightweight, wear-resistant and easy to maintain. It is also resistant against humidity and splashed water, offering the user greater flexibility.

Its modern design has functional advantages as well. The front plastic flap prevents pinching the fingers in the joint gap and also protects the cosmetic foam cover.

To adjust the prosthetic alignment or to compensate for a hip flexion contracture, the proximal pyramid adapter can be shifted in the A/P direction.



 646D339

 647G340



1

2

3

4

5

6

7

8

9

10

11

12

13

14

1
2
3
4
5
6
7
8
9
10
11
12
13
14



647G82

3R40 Modular Lightweight Single Axis Knee Joint with Lock

The upper joint section with pyramid adapter and lower joint section with tube clamp are connected through an axis. The adjustable manual lock in the lower joint section secures the joint in the extension position. The lock is released using the lock cable.



Article number	3R40
Mobility grade	1
Material	Aluminum
Proximal connection	Pyramid Adapter
Distal connection	Tube clamp Ø 30 mm
Knee flexion angle	155 °
System height	23 mm
proximal system height to alignment reference point	1 mm
distal system height to alignment reference point	22 mm
Weight	290 g
Max. body weight	100 kg

- Use the 3R24 or 3S124 Foam Cover for the 3R40. Fabrication of a customised cosmetic foam cover is possible. See the pages 184, 202, 297
- For accessory see the pages 184, 202, 297

Single Components for 3R40 as Spare Parts

4D16 Single Component Pack

Article number	4D16
for	3R40
Consisting of	1 plastic cap 2 set screws 1 lock bale with cable guide 5 pcs. perlon cable 1 threaded fitting, short 1 cable clamp 1 plastic ring 2 stops 1 pad button with thread 1 lamination plate with bore hole 1 lock slide

Modular Single Axis Knee Joint, with Lock and Extension Assist

The upper and lower joint sections are connected through the knee axis by bushings and ball bearings. The adjustable lock secures the joint in extension. The lock is released using the lock cable. Locking occurs automatically at full extension with assistance from the extension assist spring.



647G34

Article number	3R33	3R17
Mobility grade	1	
Material	Titanium	Stainless steel
Proximal connection	Pyramid Adapter	
Distal connection	Pyramid Adapter	
Knee flexion angle	120 °	
System height	43 mm	
proximal system height to alignment reference point	6 mm	
distal system height to alignment reference point	37 mm	
Weight	530 g	695 g
Max. body weight	125 kg	150 kg

- Use the 3R24 or 3S124 Foam Cover for the 3R33 and 3R17. Fabrication of a customised cosmetic foam cover is possible. See Page 297

Single Components for 3R33 and 3R17 as Spare Parts

4D10 Single Component Pack

Article number	4D10
for	3R33 3R17
Consisting of	1 plastic cap 2 bushings 1 compression spring 1 set screw 1 safety plate 1 oval head countersunk screw 1 rubber bumper 2 ball thrust bearings 2 compression springs 2 spring guide pins 2 set screws 1 spring guide housing 1 tab guide pin

1

4F18=N Lock + Accessories as Spare Parts

2

4D11 Single Component Pack

3

Article number	4D11
for	4F18=N
Consisting of	1 lock slide 1 threaded fitting, short 1 cable clamp 5 pcs. perlon cable 2 pad buttons and thread 1 lamination plate with bore hole

4

Accessories for 3R41, 3R40, 3R33, 3R17 and 3R93

• Order separately as necessary.

5



4F34 Locking Unit

For use both left and right, adjustable for push and pull. Can be used instead of the factory-installed 4F18=N Lock Slide.

6

Article number	4F34
Consisting of	1 housing 1 grip 1 cover 1 oval head screw 1 clamping bushing 2 raised head wood screws 1 Allen wrench

7

8

9

10

11

12

13

14

Modular Monocentric Knee Joint with Friction Brake, with Extension Assist and Protective Sleeve

The swing block is connected to the upper joint section through the swing axis and with the lower joint section through the knee axis and acts as a load-dependent brake. This together with proper knee alignment secures the stance phase. To control the swing phase, the axis friction and the spring force of the extension assist are adjustable.



Article number	3R49	3R15
Mobility grade	1 + 2	
Material	Titanium	Stainless steel
Proximal connection	Pyramid Adapter	
Distal connection	Pyramid Adapter	
Knee flexion angle	150 °	
System height	9 mm	
proximal system height to alignment reference point	8 mm	
distal system height to alignment reference point	1 mm	
Weight	360 g	490 g
Max. body weight	100 kg	



647H84

- Use the 3R6 or 3S106 Foam Cover for the 3R49 and 3R15. Fabrication of a customised cosmetic foam cover is possible. See Page 297

Single Components for 3R49 and 3R15 as Spare Parts

21Y70=N Protective Sleeve

External sleeve made of injection-moulded granulate to protect the knee joint, extension assist unit and cosmetic foam cover or clothing.

Article number	21Y70=N
-----------------------	----------------



4D1 Single Component Pack

Article number	4D1
Consisting of	<ul style="list-style-type: none"> 1 brake bushing 1 stop 1 bumper 2 bearing washers (large) 2 bearing washers (small) 2 lock rings 2 stops 1 safety device for bushing 1 axis screw 8 play adjustment washers

1
2
3
4
5
6
7
8
9
10
11
12
13
14



647G72

Ottobock Habermann Modular Polycentric Knee Joint with Internal Extension Assist

Upper and lower joint sections are connected by linkage bars. Stance phase stability is achieved through polycentric kinematics (instantaneous centre of rotation is set by adjusting the stop). Swing phase control is adjustable using axis friction and the extension assist spring.



Article number	3R36	3R20
Mobility grade	1 + 2	
Material	Titanium	Stainless steel
Proximal connection	Pyramid Adapter	
Distal connection	Pyramid Adapter	
Knee flexion angle	110 °	
System height	41 mm	
proximal system height to alignment reference point	- 3 mm	
distal system height to alignment reference point	44 mm	
Weight	445 g	820 g
Max. body weight	100 kg	

- Use the 3R24 or 3S124 foam cover for the 3R36 and 3R20. Fabrication of a customised cosmetic foam cover is possible. See Page 297

Single Components for 3R36 and 3R20 as Spare Parts

4D13 Single Component Pack

Article number	4D13
Consisting of	1 plastic cap 1 cap screw 1 knee stop, complete 1 extension bumper 1 pin for extension assist 1 extension assist spring 1 adjustment screw 1 ball 2 lock nuts 2 axis pins 4 bearing washers 4 rounded washers

3R93 Modular Friction Brake Knee Joint with Lock

The modern therapy knee joint

The 3R93 is a monocentric knee joint with a load-dependent brake mechanism and an optional locking function. An integrated, adjustable extension assist spring controls the swing phase.



Article number	3R93
Mobility grade	1 + 2
Material	Aluminum
Proximal connection	Pyramid Adapter
Distal connection	Tube clamp, 34 mm Ø
Knee flexion angle	130 °
System height	82 mm
proximal system height to alignment reference point	8 mm
distal system height to alignment reference point	74 mm
Weight	760 g
Scope of delivery	710H10=2X3 Adjustment Wrench 4F18=N Lock Slide 4G650 Pull Cable, complete
Max. body weight	125 kg

- Use the 3S107 or 3S106 Foam Cover for the 3R93. Fabrication of a customised cosmetic foam cover is possible.

The 3R93 effectively supports the therapy process following the amputation. This makes it the right knee joint from the first standing and walking exercises with the interim prosthesis all the way to the definitive fitting. Thanks to its design, the 3R93 can be used as a locked knee joint with manual lock release and as a knee joint with friction brake once the prosthesis wearer's mobility has increased.

When the locking function is activated, it secures the joint in the extended position. The user pulls on a cable to release the joint so it can bend for sitting.

The locking function can also be permanently deactivated by the prosthetist.

When the locking function is permanently deactivated, knee stability is achieved through the brake mechanism that blocks the joint in the flexion direction under load. The brake activates when load is applied to the heel and stabilises the prosthesis during the entire stance phase. The brake also offers the desired security when stepping down with a slightly flexed knee joint. The braking action can be adjusted easily and reproducibly (see upper figure).

To initiate the swing phase, the user relieves the load on the prosthesis which deactivates the brake. The integrated extension assist spring (see lower figure), which can be optimally adjusted from the outside, controls the pendulum motion of the prosthetic lower leg.



646D527=DE

647G525



Practical recommendation:

The 3R93 Modular Friction Brake Knee Joint with Lock is not suitable for patients with:

- Hip disarticulation
- Hemipelvectomy
- Bilateral amputation

1
2
3
4
5
6
7
8
9
10
11
12
13
14

Accessories for 3R93

• Order separately as necessary.



4D29 Single Component Pack for sealing sleeve

Article number	4D29
Consisting of	Isopropyl alcohol 1 leg spring left right 4 safety caps 1 sealing sleeve 1 felt strip

Single Components for 3R93 as Spare Parts

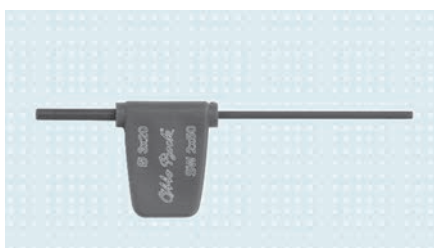

710H10=2X3 Adjustment Wrench

Article number	710H10=2X3
-----------------------	-------------------



4G650 Pull Cable, complete

Article number	4G650
Consisting of	1 perlon cable 1 cable clamp 1 simplex hook 1 expansion spring 1 threaded fitting, short



4F18=N Lock Slide

complete

Article number	4F18=N
Consisting of	1 lock slide (4F17) 1 pad button with thread 1 lamination plate with bore hole

3R90 Modular Knee Joint with Friction Brake, Monocentric with Mechanical Extension Assist

The innovative load-dependent brake mechanism offers targeted safety for the patient. Heel strike activates the brake and provides high stability in the stance phase. The swing phase can be controlled by means of a mechanical extension assist which, integrated in the lower section of the joint, has a progressively acting spring combination.



Article number	3R90
Mobility grade	1 + 2
Material	Aluminum
Proximal connection	Pyramid Adapter
Distal connection	Tube Clamp
Knee flexion angle	135 °
System height	97 mm
proximal system height to alignment reference point	8 mm
distal system height to alignment reference point	89 mm
Weight	745 g
Max. body weight	125 kg

- Use the 3S107 Foam Cover for the 3R90 and 3R92. Fabrication of a customised cosmetic foam cover is possible. See Page 299

Two combined spring elements form the integrated mechanical extension assist of the 3R90. The interaction of the springs results in an extension assist effect dependent on the knee angle. It can be preset to one of 5 different levels by means of a ratchet unit.



 647G113



Practical recommendation:

- When fitting users with mobility grade 1, the following applies: these knee joints with friction brake are contraindicated for unsure patients who are unable to systematically use the braking mechanism during the gait cycle i.e. to lock the knee joint at heel contact and unlock it when the forefoot is loaded.

1
2
3
4
5
6
7
8
9
10
11
12
13
14



647G113

3R92 Modular Knee Joint with Friction Brake, Monocentric with Pneumatic Swing Phase Control

Same brake mechanism as the 3R90. The lower joint section is formed as a pneumatic cylinder. To control the swing phase, flexion and swing phase damping of the progressively acting dual-chamber pneumatic system are individually adjustable.

Extension and flexion damping of the integrated dual-chamber pneumatics in the 3R92 can be regulated with a screwdriver in the accustomed manner.



Article number	3R92
Mobility grade	2 + 3
Material	Aluminum
Proximal connection	Pyramid Adapter
Distal connection	Tube Clamp
Knee flexion angle	135 °
System height	154 mm
proximal system height to alignment reference point	8 mm
distal system height to alignment reference point	146 mm
Weight	895 g
Max. body weight	125 kg

- Use the 3R107 Foam Cover for the 3R92. Fabrication of a customised cosmetic foam cover is possible. See Page 299



Practical recommendation:

- When fitting users with mobility grade 1, the following applies: these knee joints with friction brake are contraindicated for unsure patients who are unable to systematically use the braking mechanism during the gait cycle i.e. to lock the knee joint at heel contact and unlock it when the forefoot is loaded.

3R78 Polycentric Knee Joint with Pneumatic Swing Phase Control

The development of the 3R78 focused on a robust, dust-resistant design that is durable and resistant against environmental impacts. This new polycentric prosthetic knee joint with pneumatic swing phase control offers reliable stance phase security for users with moderate activity levels. Get to know the 3R78 and see the advantages for yourself.



Reference number	3R78
Mobility grade	2 + 3
Material	Aluminum
Proximal connection	Pyramid Adapter
Distal connection	Tube clamp Ø30 mm
Knee flexion angle	150 °
System height	156 mm
proximal system height to alignment reference point	-7 mm
distal system height to alignment reference point	163 mm
Weight	750 g
Max. body weight	100 kg



 646D560=DE

 647G556
647H536

- Use the 3R6 or 3S106 Foam Cover for the 3R78. Fabrication of a customised cosmetic foam cover is possible. Page 296
- Not available in the US**

Single-chamber pneumatics control the swing phase

In the swing phase, the smooth yet powerful single-chamber pneumatics – one chamber each for flexion and extension damping – do not run out of air, even at various walking speeds. Smooth flexion and extension movements, and therefore an approximation of the physiological gait pattern, are made possible. Here the joint geometry effectively shortens the prosthesis during swing through, resulting in more ground clearance.

1

2

3

4

5

6

7

8

9

10

11

12

13

14

1
2
3
4
5
6
7
8
9
10
11
12
13
14



i 646S1=6.05 **📖** 647H208

3R106 Modular Polycentric Knee Joint with Pneumatic Swing Phase Control

The stance phase is secured due to the 4-axis joint design. Power dual-chamber pneumatics with integrated extension assist spring ensure harmonious pendulum movements of the prosthetic lower leg, even at higher walking speeds.

Advantages of 3R106

- The upper joint section and lower joint section are connected by the anterior links and the mid-joint section to form a four-bar linkage. In the extended position, the instantaneous pivot point is located clearly above the joint and behind the load line. Therefore the modern polycentric structure reliably stabilises the knee joint during stance phase and provides for increased ground clearance during the swing phase – thus enhancing the user’s confidence in the prosthesis as a whole.
 - Advantageous swing phase damping characteristics, especially easy initiation of the swing phase, smooth extension stop for a natural gait with reduced energy consumption.
 - Flexion and extension damping are individually adjustable. To reduce the force of the extension assist, the extension assist spring can simply be replaced by a weaker one that is additionally included in the delivery.
 - The wide flexion angle of 170° and the light weight also provide for high comfort, e.g. when bicycling, getting into a car, kneeling or sitting.
 - Suitable for all amputation levels with various proximal connection versions.
- Use the 3R107 Foam Cover for the 3R106. Fabrication of a customised cosmetic foam cover is possible. See Page 299



Article number	3R106	3R106=HD*	3R106=ST	3R106=KD
Mobility grade	2 + 3			
Material	Aluminum			
Proximal connection	Pyramid Adapter	Pyramid Adapter (10° inclined)	Threaded Connector	Lamination Anchor
Distal connection	Tube clamp	Tube Clamp		
Knee flexion angle	170 °			
System height	162 mm	164 mm	180 mm	184 mm
proximal system height to alignment reference point	-6 mm	-4 mm	12 mm	16 mm
distal system height to alignment reference point	168 mm			
Weight	760 g	790 g	765 g	755 g
Scope of Delivery	All versions of the 3R106 Modular Knee Joint are supplied with a Ø 30 mm tube adapter and an additional, weaker extension assist spring.			
Max. body weight	100 kg			

* Using the especially adapted version of the 3R106=HD is mandatory when fitting prosthesis wearers with hip disarticulation or hemipelvectomy; using the 4R39 Torsion Adapter is also recommended.

Single Components for 3R106 as Spare Parts

4D3 Single Component Pack

Article number	4D3
for	3R106
Consisting of	1 stop 4 truss head screws 4 two-hole nuts 3 set screws, Allen head

- 1
- 2
- 3
- 4
- 5
- 6
- 7
- 8
- 9
- 10
- 11
- 12
- 13
- 14

1
2
3
4
5
6
7
8
9
10
11
12
13
14



646S1=24.04 647G167

3R60 Modular Polycentric EBS Knee Joint with hydraulic swing phase control

The main objective of prosthetic fittings is to achieve the best possible replacement of various functions offered by the sound limb. At Ottobock, we strive to continuously get closer to this objective through intensive research and the development of modern knee joints.

In the field of mechanical knee components, we have taken a big step in this direction with the 3R60 EBS* – with distinction!

Get to know the next generation of the 3R60 which has proven itself thousands of times. With improved EBS* function for controlled knee flexion at heel strike and new, powerful swing phase control hydraulics.

Comfort and safety are ensured by the unique characteristic of the EBS elastic flexion unit, which simulates the biomechanics of the natural gait.

Available with 4 different connections.

- Use the 3R107 Foam Cover for the 3R60. Fabrication of a customised cosmetic foam cover is possible. See Page 299



Article number	3R60	3R60=HD*	3R60=ST	3R60=KD
Mobility grade	2 + 3			
Material	Aluminum			
Proximal connection	Pyramid Adapter	Pyramid Adapter (10° inclined)	Threaded Connector	Lamination Anchor
Distal connection	Pyramid Adapter			
Knee flexion angle	175 °		125 °	145 °
System height	171 mm	174 mm	189 mm	193 mm
proximal system height to alignment reference point	-2 mm	1 mm	16 mm	20 mm
distal system height to alignment reference point	173 mm			
Weight	845 g	880 g	845 g	940 g
Max. body weight	125 kg			

* Using the especially adapted version of the 3R60=HD is mandatory when fitting prosthesis wearers with hip disarticulation; using the 4R86 Torsion Adapter is also recommended.

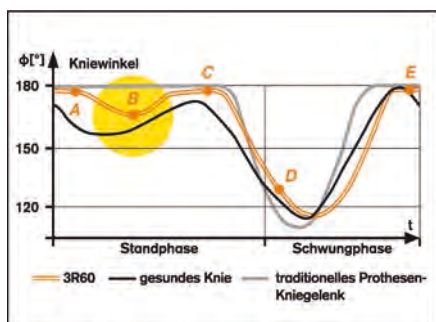

What is the effect of the EBS feature?

At heel strike, it is easy to observe that the natural knee is flexed. This important process is the basis for the functionality of the 3R60 EBS Knee Joint.

Thanks to the polycentric joint structure, the 3R60 at heel strike permits controlled, resilient flexion to max. 15° without initiating normal knee flexion (phase B, see graphic).

This individually adjustable stance phase flexion provides additional knee stability for the user and considerably reduces the load on the residual limb, hip and spine. Walking with the prosthesis becomes more comfortable and physiological – close to the sound, natural model.

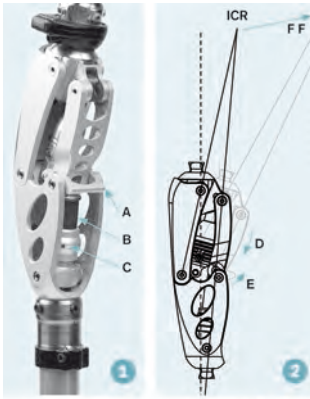

How does the EBS feature work?

With polycentric knee joints, the instantaneous centre of rotation (ICR) is located where the extensions of the posterior and anterior knee axes cross (Figure 2). The location of the centre of rotation during impact largely determines the safety of the prosthesis.

Two axial forks connect the upper and lower joint section to one another and create a kinematic chain. A pivoting mount (Fig. 1, A) joins the lower joint section to the rear axial fork, which is also connected to the shock absorbing elements of the EBS unit (Fig. 1, B and C).

The multiaxial action of the joint is composed of rotary and gliding movements. At heel strike, the proximal joint sections swing around the lower axes to dorsal (Fig. 2, D). The instantaneous centre of rotation (ICR) varies with the flexion position. With increasing stance phase flexion, additional stability of the prosthesis is achieved by shifting the centre of rotation posterior and proximally behind the load line (Fig. 2, F).

Compared to conventional prosthetic knee joints, knee safety of the prosthesis increases significantly with knee flexion.

The blue elastomer block (Fig. 1, B) of the EBS unit is compressed during the flexion process, while the pivoting mount moves up (Fig. 2, E). The resistance of the EBS function is continuously adjustable and can be individually tailored to the weight and activity level of the patient. The movement of the pivoting mount serves to visually verify the efficiency of the EBS function (Fig. 3).

Integrated hydraulics harmonise the EBS effect and ensure damping in stance phase extension.

Additional Benefits

- The hydraulic resistances of the optimised swing phase hydraulics are independently adjustable (Fig. 4). Optimised damping values are based on gait analysis data and support the easy initiation of the swing phase in addition to enabling the user to walk at a wider range of speeds.
- Improved EBS function, individually adjustable to the weight and activity of the patient (Fig. 5) for significantly enhanced comfort and safety in everyday life. Compared to conventional multi-axis joints, the 5-axis design of the 3R60 in combination with the EBS function makes walking on uneven terrain and gentle inclines unproblematic. The polycentric structure improves ground clearance in the swing phase.
- The large flexion angle of max. 175° (Fig. 6), dampened by the EBS unit from approx. 155°, helps the user surmount the obstacles of daily life. The weight and system height were reduced compared to the predecessor model, while the max. allowable user weight was increased to 125 kg (275 lbs).

1

2

3

4

5

6

7

8

9

10

11

12

13

14

1
2
3
4
5
6
7
8
9
10
11
12
13
14



646D303 647G381

3R60-PRO Modular EBS^{PRO} Polycentric Knee Joint with hydraulic swing phase control

Comfort and safety are ensured by the unique characteristic of the advanced ergonomically balanced stride unit EBS^{PRO}, which simulates the biomechanics of the natural gait. Available with 4 different connections.

- The proven design allows controlled stance phase flexion of up to 15° and thus comfortable walking with high safety even on rough terrain and on inclines of up to 10°.
- Progressive damping of stance phase flexion as well as stance phase extension provides for smooth, natural movements under load.
- Possible for the first time: adaptation of stance phase flexion to various everyday situations.
- The EBS^{PRO} function reduces stress on both limbs. In addition, it reduces the forces acting on the residual limb, pelvis and spine while closely approximating a sound, physiological gait pattern.
- The 5-axis design provides greater protection in high-risk situations: the wearer can always flex the joint in controlled manner without delay or prior full extension, so there is less risk of falling than with geometrically locking knee joints.
- Easy initiation of the swing phase and progressive damping for focused control of the pendulum motion of the lower leg.
- Low weight and a very large flexion angle of 175° for greater freedom of movement.
- Adjustment of prosthetic alignment using the movable pyramid adapter, e.g. to adapt to flexion contractures.
- All amputation levels can be fitted thanks to individual connectors.
- Attractive and natural cosmetic appearance.

• Use the 3R107 Foam Cover for the EBS^{PRO}. Fabrication of a customised cosmetic foam cover is possible. See Page 299



Article number	3R60-PRO	3R60-PRO=HD*	3R60-PRO=KD	3R60-PRO=ST
Mobility grade	2 + 3			
Material	Aluminum			
Proximal connection	Pyramid adapter (movable)	Pyramid Adapter (10° inclined)	Lamination Anchor	Threaded Connector
Distal connection	Pyramid Adapter			
Knee flexion angle	175 °		145 °	125 °
System height	150 mm		169 mm	165 mm
proximal system height to alignment reference point	2 mm		21 mm	17 mm
distal system height to alignment reference point	148 mm			
Weight	770 g		840 g	750 g
Max. body weight	75 kg			

* Using the especially adapted version of the 3R60-PRO=HD is mandatory for hip disarticulation fittings



How does the EBS^{Pro} work?

The mechanical principle of the EBS^{Pro} is based on the proven 3R60 Knee Joint.

The polycentric joint has five axes that are arranged to form a ring. The anterior axis chain is designed like a conventional four-axis joint, but the posterior linkage bar is interrupted by an additional pivot point (Fig. 1). In this way, the proven design allows for two different modes of operation: the swing phase mode and the stance phase flexion mode. Two especially configured miniature hydraulic units (Fig. 2, A+B) control the two modes. Outstanding performance during the stance phase is the key feature of the 3R60.

The spring and hydraulics combination in stance phase flexion mode is individually adjustable and can be precisely adapted to suit the requirements of the prosthesis wearer. Thanks to the progressivity of the EBS resistance – realised with an auto-adaptive EBS unit – the effectiveness can adapt itself over a large range of walking speeds for the first time.

The higher the speed, the greater the extent to which flexion is limited. The lower the walking speed, the less damping resistance takes effect which ensures greater stance phase flexion (Fig. 3). In this way, this important function adapts to various everyday situations. For the prosthesis wearer, this means enhanced safety and comfort as well as a highly natural gait pattern.

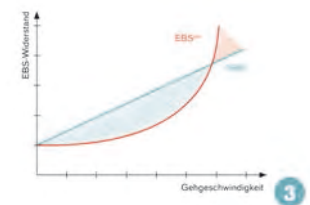
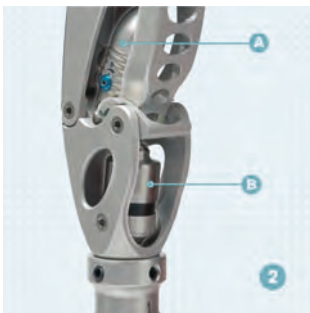

1

2

3

4

5

6

7

8

9

10

11

12

13

14

1
2
3
4
5
6
7
8
9
10
11
12
13
14



i 646S1=8.07 **Y** 647G403
647H515

3R80 Modular Monocentric Knee Joint with Rotary Hydraulics

The 3R80 with its unique rotation hydraulics principle is now also approved for prosthesis wearers with a body weight of up to 150 kg (330 lbs). With the 3R80, both the stance and the swing phase are controlled by the hydraulics. For example, walking down stairs step-over-step and walking down inclines are effectively supported by closely approximating a physiological gait pattern, even at various walking speeds.



Article number	3R80
Mobility grade	3 + 4
Material	Aluminum
Proximal connection	Pyramid Adapter
Distal connection	Tube Clamp
Knee flexion angle	150 °
System height	163 mm
proximal system height to alignment reference point	28 mm
distal system height to alignment reference point	135 mm
Weight	1225 g
Scope of Delivery	2R57 Tube Adapter Ø 34 mm More powerful extension assist spring Quick Reference Guide
Max. body weight	150 kg

- Use the 3S107 Foam Cover for the 3R80.
Fabrication of a customised cosmetic foam cover is possible.
See Page 299



A Confident Step

Amputees must be able to rely on their prosthesis, especially in the stance phase. The rotation hydraulics of the 3R80 respond to the ground reaction forces in the stance phase at every step. They build up high hydraulic resistance, which prevents involuntary flexion of the joint.

Extensive adjustment possibilities

The 3R80 offers comprehensive adjustment possibilities for the individual adaptation of stance and swing phase characteristics. Flexion and extension resistance can be adjusted easily and independently. Optimum adjustment values for stance phase damping and response behaviour between the stance and swing phase are achieved by gradually turning the adjustment rings.

The level of resistance in the stance phase can be easily adapted to the requirements of the user, and enables variable knee flexion under load up to 4° while bouncing, and more than 4° while yielding.

An additional spring can be integrated very easily in order to increase the extension assist force if required. The spring, setting aid and required tube adapter are included in the scope of delivery.

Single Components for 3R80 as Spare Parts

2R77 Tube Adapter



≤ 150 kg

Article number	2R77
Diameter	34 mm
Min. system height	77 mm
Max. system height	472 mm
Weight	370 g
Max. body weight	150 kg



647G180=1

2R58 Tube Adapter

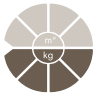

≤ 150 kg

Article number	2R58
Diameter	34 mm
Material	Titanium
Min. system height	77 mm
Max. system height	472 mm
Weight	330 g
Max. body weight	150 kg



647G180=1

1

2

3

4

5

6

7

8

9

10

11

12

13

14

1
2
3
4
5
6
7
8
9
10
11
12
13
14



i 646S1=7.04 647G257

3R95 Modular Knee Joint, Monocentric, with Hydraulic Swing Phase Control

Small, lightweight and with powerful linear hydraulics for swing phase control. Particularly well suited for highly active users. Also available as the 3R95=1 with especially adapted characteristics for prosthesis wearers with a body weight less than 75 kg (165 lbs). Here the hydraulics for swing phase control are adapted to the lower pendulum mass and length compared to the 3R95. The joint housing has a dorsal recess to allow for a larger flexion angle.

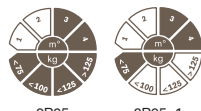

3R95
≤ 150 kg (330 lbs)

3R95=1

Article number	3R95	3R95=1
Mobility grade	3 + 4	
Material	Aluminum	
Proximal connection	Pyramid Adapter	
Distal connection	Pyramid Adapter	
Knee flexion angle	135 °	155 °
System height	62 mm	
proximal system height to alignment reference point	6 mm	
distal system height to alignment reference point	56 mm	
Weight	360 g	340 g
Max. body weight	150 kg	75 kg

- Use the 3R24 or 3S124 Foam Cover for the 3R95/3R95=1. Fabrication of a customised cosmetic foam cover is possible. See Page 297

Additional Features

- The flexion and extension resistance used to control the swing phase can be adjusted separately and precisely using a scale on the joint.
- The design of the hydraulic linkage geometry allows powerful resistance even with a high degree of flexion. The extension resistance can be set to a low value, since hydraulic end position damping ensures a soft transition to the elastic stop.
- The stance phase is secured by posterior placement of the joint and active control by the user.
- Cosmetically very advantageous thanks to the compact design.

Single Components for 3R95 and 3R95-1 as Spare Parts

4D17 Single Component Pack

Article number	4D17
for	3R95 3R95=1
Consisting of	1 oval head countersunk screw 1 extension stop bumper

3R55 Modular Polycentric Knee Joint with Hydraulic Swing Phase Control

Upper and lower joint sections are connected to one another by linkage bars. Stance phase stability is achieved through polycentric kinematics. The swing phase is controlled by the built-in hydraulic cylinder. Flexion and extension resistance are independently adjustable.



 647H30

Article number	3R55
Mobility grade	3 + 4
Material	Titanium
Proximal connection	Pyramid Adapter
Distal connection	Pyramid Adapter
Knee flexion angle	110 °
System height	90 mm
proximal system height to alignment reference point	9 mm
distal system height to alignment reference point	81 mm
Weight	720 g
Max. body weight	125 kg

- Use the 3R6 or 3S106 Foam Cover for the 3R55. Fabrication of a customised cosmetic foam cover is possible.
See Page 296

Single Components for 3R55 as Spare Parts

4D19 Single Component Pack

Article number	4D19
for	3R55
Consisting of	<ul style="list-style-type: none"> 2 stops 1 damper protection 2 attachment nipples, short 1 attachment nipple, long 4 slotted bushings 4 Belleville spring washers 2 lock rings 2 lock nuts

1

2

3

4

5

6

7

8

9

10

11

12

13

14

1
2
3
4
5
6
7
8
9
10
11
12
13
14

Modular Knee Joints for Knee Disarticulation

Modular knee joints designed exclusively for knee disarticulation are described in the following section. KD joint versions that are also offered with a pyramid adapter (3R60, 3R106, C-Leg product line) can be found with the help of our quick search feature on the pages 192, 194, 206, 208.



647H20

Modular Knee Joint for Knee Disarticulation, Polycentric, with Manual Lock

The upper joint section with coupling unit and lower joint section with pyramid adapter are connected to one another by anterior and posterior linkage bars. The detachable lamination anchor connects the knee to the prosthetic socket. The adjustable lock secures the knee in extension. The lock is released using the lock cable.



Article number	3R32	3R23
Mobility grade	1	
Material	Titanium	Stainless steel
Proximal connection	Lamination Anchor	
Distal connection	Pyramid Adapter	
Knee flexion angle	110 °	
System height	99 mm	
proximal system height to alignment reference point	17 mm	
distal system height to alignment reference point	82 mm	
Weight	655 g	880 g
Max. body weight	125 kg	

- Use the 6R6 (3R6, 3S106) Foam Cover for the 3R32 and 3R23. Fabrication of a customised cosmetic foam cover is possible. See the pages 295-296

Accessories for 3R32/3R23

- Order separately as necessary.



4F34 Locking Unit

For use both left and right, adjustable for push and pull. Can be used instead of the factory-installed 4F18=N Lock Slide.

Article number	4F34
Consisting of	1 housing 1 grip 1 cover 1 oval head screw 1 clamping bushing 2 raised head wood screws 1 Allen wrench

Single Components for 3R32 and 3R23 as Spare Parts

4D9 Single Component Pack

Article number	4D9
Consisting of	4 slotted bushings 4 Belleville spring washers 2 lock rings 3 set screws 2 lock nuts 2 stops 4 truss head screws 4 two-hole nuts

1

2

3

4

5

6

7

8

9

10

11

12

13

14

1
2
3
4
5
6
7
8
9
10
11
12
13
14



647G44

Modular Knee Joint for Disarticulation, Polycentric, with Mechanical Extension Assist

The upper joint section with lamination anchor and lower joint section are connected by anterior and posterior linkage bars. The detachable lamination anchor connects the knee to the prosthetic socket. Stance phase stability is achieved through polycentric kinematics. The extension assist spring and axial friction are both continuously adjustable.



Article number	3R30	3R21
Mobility grade	1 + 2	
Material	Titanium	Stainless steel
Proximal connection	Lamination Anchor	
Distal connection	Pyramid Adapter	
Knee flexion angle	110 °	
System height	99 mm	
proximal system height to alignment reference point	17 mm	
distal system height to alignment reference point	82 mm	
Weight	655 g	1010 g
Max. body weight	125 kg	

- Use the 6R6 (3R6) Cosmetic Foam Cover for the 3R30 and 3R21. Fabrication of a customised cosmetic foam cover is possible. See the pages 295-296

Single Components for 3R30 and 3R21 as Spare Parts

4D7 Single Component Pack

Article number	4D7
Consisting of	4 slotted bushings 4 Belleville spring washers 1 set screw 2 lock rings 2 lock nuts 2 stops 1 extension assist spring 1 bearing for extension assist 1 guide for extension assist 1 plastic guide 1 knob for extension assist 4 truss head screws 4 two-hole nuts 2 set screws

3R46 Modular Knee Joint for Disarticulation, Polycentric, with Hydraulic Swing Phase Control

The upper joint section and lower joint section with pyramid adapter are connected to one another by anterior and posterior linkage bars. The detachable lamination anchor connects the knee to the prosthetic socket. Stance phase stability is achieved through polycentric kinematics. The swing phase is controlled by the built-in hydraulic cylinder. Flexion and extension resistance are independently adjustable.



Article number	3R46
Mobility grade	3 + 4
Material	Titanium
Proximal connection	Lamination Anchor
Distal connection	Pyramid Adapter
Knee flexion angle	110 °
System height	99 mm
proximal system height to alignment reference point	17 mm
distal system height to alignment reference point	82 mm
Weight	740 g
Max. body weight	125 kg



 647G94

- Use the 6R6 (3R6) Foam Cover for the 3R46.
Fabrication of a customised cosmetic foam cover is possible.
See the pages 295-296

Single Components for 3R46 as Spare Parts

4D18 Single Component Pack

Article number	4D18
Consisting of	2 stops 4 truss head screws 4 two-hole nuts 1 damper protection 2 attachment nipples, short 1 attachment nipple, long 4 slotted bushings 4 Belleville spring washers 3 set screws 2 lock rings 2 lock nuts

1
2
3
4
5
6
7
8
9
10
11
12
13
14



C-Leg Knee Joints

The C-Leg is the world's first fully microprocessor-controlled hydraulic leg prosthesis system. Since its market launch, it has set new standards for safety, regained mobility and quality of life for users.

The strain gauges in the tube adapter and a knee angle sensor record the anterior and posterior flexion moment and the angular velocity of the knee joint every 0.02 seconds. Based on these measurements, the microprocessors calculate the required movement resistance. Servomotors correspondingly open and close hydraulic valves to provide the required flexion and extension damping. As a result, the C-Leg adjusts to the requirements of the user in real time and thus ensures a very high level of dynamics and safety.

The next generation of the C-Leg was presented in 2011, retaining the proven advantages of the leg prosthesis system and adding important new functionality:

 647H215=D/GB/F/E Instructions for Use

- Mechanical and electronic adjustments have resulted in improved swing phase control. The new C-Leg allows the user to achieve a gait pattern even closer to a natural one, with easier, smoother movement of the knee joint.
- Optimised stumble recovery offers enhanced security. Adjustments to the damping behaviour of the knee joint in critical situations where the user stumbles permit faster compensation with the sound leg, resulting in even more reliable prevention of falls.
- Further developments of the knee joint frame have made the C-Leg even more robust. It is now approved for a maximum body weight of 136 kg* (300 lbs) when used in combination with the appropriate tube adapter.
- The user also benefits from other innovations such as an additional activity mode (3rd mode), adjustable damping behaviour when the battery is drained, and improved splash protection of the C-Leg knee joint.

* Only with 2R82=120, =160, =200 and =240 Tube Adapter



Reference number	3C98-2	3C88-2
Mobility grade	3 + 4	
Material	Carbon	
Proximal connection	Pyramid Adapter	Threaded Connector
Distal connection	Tube Clamp	
Knee flexion angle	125 °	
System height	196 mm	214 mm
proximal system height to alignment reference point	5 mm	23 mm
distal system height to alignment reference point	191 mm	
Weight (without tube adapter)	1,143 g	1,147 g
Max. body weight	136 kg	



Reference number	3C98-2=7.1	3C88-2=7.1
Mobility grade	3 + 4	
Material	Carbon	
Proximal connection	Pyramid Adapter	Threaded Connector
Distal connection	Tube Clamp	
Knee flexion angle	125 °	
System height	196 mm	214 mm
proximal system height to alignment reference point	5 mm	23 mm
distal system height to alignment reference point	191 mm	
Weight (without tube adapter)	1,143 g	1,147 g
Max. body weight	136 kg	

1

2

3

4

5

6

7

8

9

10

11

12

13

14

1

Cover
for charging system and adjustment software
NEW:
Special protective silicone cover

2

3

4

Electronic Control
A modern microprocessor is the heart of the C-Leg system. It receives and processes the sensor signals and controls the movements of the knee joint in real time.
NEW:
Optimised Stumble Recovery

5

6

7

Carbon Fibre Frame
Carbon is an especially strong, high-grade, and lightweight modern material.
The frame protects the electronics, hydraulics and battery, and gives the C-Leg its elegant shape.
NEW:
Max. body weight: 136 kg (300 lbs)

8

9

10

11

Wireless Remote Control
The remote control allows you to activate different modes.
These permit special activities such as cycling, inline skating or cross-country skiing.

12

13

14



Knee Angle Sensor
In a fraction of a second, it supplies the microprocessor with important data on the speed and angle of the knee.

Lithium-Ion Battery
A lithium-ion battery provides the energy required to control the knee joint. It is located directly in the rotation axis of the C-Leg. The maximum operating time is 45 hours.

Hydraulic Unit
The microprocessor controls two independent hydraulic valves. They maintain the correct level of movement resistance during flexion and extension in the stance and swing phases.
NEW:
• Improved swing phase control
• Additional activity mode (3rd mode)



C-Leg Tube Adapters

• Please use the tube adapter selection disc (4X77=GB) to choose the correct length.

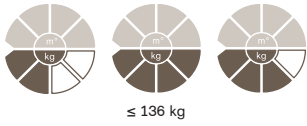

Article number	2R82=110	2R82=120	2R82=160	2R82=200	2R82=240	2R81=160	2R81=200	2R81=240	
Material	Aluminium					Aluminum			
Length	110 mm	120 mm	160 mm	200 mm	240 mm	160 mm	200 mm	240 mm	
Min. system height	147 mm	157 mm	197 mm	237 mm	277 mm	197 mm	237 mm	277 mm	
Max. system height	197 mm	207 mm	247 mm	287 mm	327 mm	247 mm	287 mm	327 mm	
Weight	178 g	188 g	212 g	234 g	256 g	438 g	460 g	482 g	
Design	Standard					Torsion unit			
Max. body weight	100 kg	136 kg				125 kg			

1

2

3

4

5

6

7

8

9

10

11

12

13

14

1
2
3
4
5
6
7
8
9
10
11
12
13
14



C-Leg compact Knee Joints

Functional Principles

The C-Leg compact continuously recognises the walking phase of the user and adjusts to it in real time. When sitting down in a chair or walking on an uneven surface, a slope or stairs, mechatronic and hydraulic stance phase control system is always active. It stabilises the joint during heel strike up to the point of precisely switching to the hydraulically controlled swing phase. Using a remote control, an optional standing function can be activated, which adds stability and comfort to any standing position the user chooses. An optimised, hydraulic swing phase setting makes walking easier and thereby offers additional security.

Area of Application

According to MOBIS, the Ottobock mobility system, the C-Leg compact is suitable for knee disarticulation, transfemoral, hip disarticulation and hemipelvectomy amputees with mobility levels 2 and 3. The maximum allowable body weight of the amputee is 125 kg. A list of indications supports you in the selection of the correct C-Leg leg prosthesis system.

646D179=GB Information for Users

647G170=GB Instructions for Use



Reference number	3C96-1	3C86-1
Mobility grade	2 + 3	
Material	Carbon	
Proximal connection	Pyramid Adapter	Threaded Connector
Distal connection	Tube Clamp	
Knee flexion angle	125 °	
System height	196 mm	214 mm
proximal system height to alignment reference point	5 mm	23 mm
distal system height to alignment reference point	191 mm	
Weight (without tube adapter)	1,215 g	1,219 g
Max. body weight	125 kg	

C-Leg Tube Adapters

Please use the tube adapter selection disc (4X77=GB) to choose the correct length.

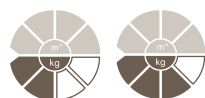

Article number	2R80=110	2R80=120	2R80=160	2R80=200	2R80=240	2R81=160	2R81=200	2R81=240
Material	Aluminum							
Length	110 mm	120 mm	160 mm	200 mm	240 mm	160 mm	200 mm	240 mm
Min. system height	147 mm	157 mm	197 mm	237 mm	277 mm	197 mm	237 mm	277 mm
Max. system height	197 mm	207 mm	247 mm	287 mm	327 mm	247 mm	287 mm	327 mm
Weight	178 g	188 g	212 g	234 g	256 g	438 g	460 g	482 g
Design	Standard					Torsion unit		
Max. body weight	100 kg	125 kg						

C-Leg Protector

C-Leg Protector: Combining Aesthetics with Function



Protection in unusual and everyday situations: the C-Leg Protector is the perfect accessory for C-Leg and C-Leg compact wearers who stand in the middle of life and who like to take on challenges. Its special coating protects the knee joint from scratches and jolts. With the C-Leg Protector you can also kneel down again – easily and comfortably without sliding.

The C-Leg Protector is a must for fashion-conscious and self-confident prosthesis wearers who choose to show their C-Leg or C-Leg compact openly in public. Its transparent and elegant design in 2 colour variations encases the knee joint and tube adapter without hiding them. The high-quality design remains visible. The C-Leg Protector also shapes the calf area without compromising the function of the knee joint.

The C-Leg Protector can be adapted by the prosthetist quickly and easily. It can be applied to either the left or right side. If need be, the C-Leg Protector can be donned, doffed, and cleaned by the prosthesis wearer in everyday life.



 647H506 Instruction for Use

Article number	4X160=1.2	4X160=5.6
Material	Plastic	
Weight	≤ 330 g	
Colour	dolphin	blue
		

Service and Spare Parts Set for the C-Leg Protector

4X177 Protector Closure Kit

Article number	4X177
Consisting of	2 calf closures 1 charging plug cover 1 ankle closure

4X178 Tube Protector Set

Article number	4X178
Consisting of	1 tube protector 1 retaining ring, long 1 retaining ring, short 1 sock band

4X202 Sock Band for C-Leg Protector

Article number	4X202
-----------------------	--------------

1

2

3

4

5

6

7

8

9

10

11

12

13

14

- 1
- 2
- 3
- 4
- 5
- 6
- 7
- 8
- 9
- 10
- 11
- 12
- 13
- 14



 647G268 C-Soft Instructions for Use

4X180 C-Soft – Auto-Adaptive Software

With C-Soft, Ottobock has developed an innovative software that supports the quick and easy adjustment of the C-Leg and C-Leg compact leg prosthesis systems.

Wireless communication between joint and laptop is performed via the BionicLink. Ottobock is the first company in the industry to use Bluetooth™ technology for this purpose. This allows you to focus entirely on your customer and on optimising the settings of the C-Leg compact/C-Leg. During the fitting, your customer can move about freely without being impeded by cables. Thanks to the BionicLink, users can also wear the cosmetic cover during the adjustment procedure. In this way, negative effects of the cosmetic cover on the control unit of the prosthesis can be compensated from the outset.

The new software is notable for its user-friendliness. Settings are menu-driven and the programme guides you step by step through the process. Additional visualisations and detailed explanations also facilitate the process. Even if you have little past experience with the prosthesis adjustments, you can provide your customers with precise and professional fittings. For example, the software supports you in performing the necessary calculation of the maximum load. You merely need to enter your customer's body weight and foot size. The programme cross-checks its own calculated result by means of a gait sequence analysis and corrects the value if needed.

Article number	4X180
for	C-Leg and C-Leg compact Adjustments



60X3 BionicLink

With the BionicLink, Ottobock is introducing Bluetooth™ technology to the field of lower limb prosthetics. Now the user can move freely and without restrictions while the C-Leg or C-Leg compact is adjusted. This is because the BionicLink allows the settings to be modified under realistic conditions using a wireless remote. During trial walking, the prosthetist can concentrate fully on the adjustment process and the verification of the gait pattern thanks to Bluetooth™ technology.

Article number	60X3
for	Connection to the C-Leg or C-Leg compact



 646D225

60X5 BionicLink PC

The BionicLink PC 60X5 supports wireless data communication between Ottobock products with a Bluetooth® interface (e. g. Dynamic Arm®) and a PC with USB port or USB hub.

The BionicLink PC is equipped with 2 LEDs. The green LED indicates that the device is ready for use. The blue LED indicates that a proper connection has been established between the product and the PC.

A proper connection between the Ottobock product and a PC can only be established using corresponding Ottobock software products (e.g. ElbowSoft).

Article number	60X5
for	Connection to the computer (USB Bluetooth™ adapter)

Accessories

757L16-2 Power Supply

For C-Leg and C-Leg compact

Article number	757L16-2
----------------	----------



1

2

3

4E50-2 Battery Charger

For C-Leg and C-Leg compact

Article number	4E50-2
----------------	--------



4

5

4X78 Charger Extension Cable

If a cosmetic foam cover makes it difficult to connect the charger cable at the designated point, we offer the charger extension cable and the plug bracket. Installed at the distal end, they permit uncomplicated charging.

Article number	4X78
----------------	------



6

7

4X79 Plug Holder for Charger Extension Cable

Article number	4X79
----------------	------

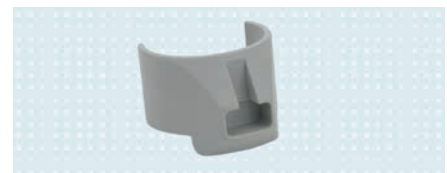

647H370

8

9

4X83=430-USB PC Interface with USB Connection Cable

Instead of using the BionicLink to establish a wireless connection between the PC and knee joint, you may use the USB connection cable as an alternative.

Article number	4X83=430-USB
----------------	--------------



647H481

10

11

12

4X77=D Tube Adapter Selection Plate for C-Leg and C-Leg compact

The selection plate allows you to quickly determine the suitable tube adapter length for the C-Leg and C-Leg compact, depending on the foot size and knee-floor measurement.

Article number	4X77=D
----------------	--------



13

14

1



4X77=GB Tube Adapter Selection Plate for C-Leg and C-Leg compact

The selection plate allows you to quickly determine the suitable tube adapter length for the C-Leg and C-Leg compact, depending on the foot size and knee-floor measurement.

2

Article number

4X77=GB

3

Single Components as Replacement Parts

4



4X73 Protective Plug for C-Leg

Article number

4X73

5

6

7

8

9

10

11

12

13

14

The Custom Fitting Package

The leg prosthesis systems in the C-Leg product line are assembled into an individual fitting package according to your wishes and the needs of your patient. MOBIS, the Ottobock mobility system, supports you in making the optimum selection. Now you can individually assemble the entire system, from the socket connection to the foot component, by selecting from our system overview shown here.

The previous numbering of the C-Leg fitting packages has been eliminated, but the C-Leg and C-Leg compact are still only available as leg prosthesis systems in order to ensure optimum fitting results.

In each case, you select:

- At least one suitable adapter
- The desired knee joint
- The tube adapter of the required length, with or without torsion unit
- The foot component in the respective version
- The preferred cosmetic cover

For the quick and uncomplicated selection of the correct tube adapter length based on the system height, an Ottobock measurement system, use the 4X77=D Tube Adapter Selection Disc (see 646K2=D "Prosthetics – Lower Limbs" catalogue, section "Leg Prosthesis Alignment"). The battery charger, power supply and cosmetic foam cover are included with every fitting package. All components – with the exception of the foot component, adapters and cosmetic foam cover – are shipped together in environmentally friendly packaging. Additional components such as software and hardware, extra options or an extended warranty (C-Leg only) may also be ordered if desired.



1

2

3

4

5

6

7

8

9

10

11

12

13

14

1

2

3

4

5

6

7

8

9

10

11

12

13

14

Adapter	<p>4R104=60 4R104=75</p> <p>4R57 4R57=ST</p> <p>4R41 4R43 4R89</p> <p>4R111=N 4R111 4R116</p> <p>4R40</p> <p>4R118</p>	<p>757L16-2</p> <p>4E50-2</p>	Battery Charger/ Power Supply
C-Leg Knee Joint	<p>with pyramid adapter</p> <p>3C98-2 C-Leg</p> <p>3C98-2=7.1 C-Leg Carbon Black Metallic</p> <p>3C96-1 C-Leg compact</p> <p>with threaded connector</p> <p>3C88-2 C-Leg</p> <p>3C98-2=7.1 C-Leg Carbon Black Metallic</p> <p>3C86-1 C-Leg compact</p>	<p>4X160=1.2</p> <p>4X160=5.6</p> <p>3S26 Cosmetic Foam Cover (not illustrated)</p> <p>3R59 Custom Cosmetic Foam Cover (not illustrated)</p>	Cosmetic Cover/Protector
Tube Adapter	<p>Tube Adapter</p> <p>=110 ≤ 100 kg/220 lbs</p> <p>=120</p> <p>=160</p> <p>=200</p> <p>=240</p> <p>2R80=* for C-Leg Compact/ 2R82=* for C-Leg</p> <p>Tube Adapter with Torsion Unit</p> <p>=160</p> <p>=200</p> <p>=240</p> <p>2R81=*</p>	<p>4X150</p> <p>4X250</p>	Remote Control
Prosthetic Feet	<p>1A30</p> <p>1D10*</p> <p>1M10*</p> <p>1D35</p> <p>1C30</p> <p>1C40</p> <p>1E56</p> <p>1E57</p> <p>1C60</p> <p>1C61</p> <p>1C62</p> <p>1C63</p> <p>1C64</p>	<p>60X3 BionicLink</p> <p>60X5 BionicLink PC</p> <p>4X180 C-Soft</p>	C-Soft/BionicLink
Single Components	<p>4X74 12-Volt Car Charging Cable</p> <p>4X78 Charger Extension Cable</p> <p>4X79 Plug Holder for Charger Extension Cable</p> <p>4X83=430-USB USB Connection Cable</p> <p>4X88=430-USB USB Connection Cable</p> <p>4X77=D Tube Adapter Selection Plate</p>	<p>4X177 Protector Closure Set (not illustrated)</p> <p>4X176 Protector Tube Set (not illustrated)</p>	

Genium Knee Joints with Remote Control

The Genium Bionic Prosthetic System is the result of extensive research and development efforts as well as more than 14 years of practical experience with the C-Leg. The latest computer, sensor and control technology make the Genium a groundbreaking achievement in lower limb prosthetics for transfemoral amputees. With this system, amputees come a giant step closer to walking naturally compared to previous prosthetic solutions.

The Genium responds intelligently to a wide variety of everyday situations through intuitive control by the user.

The OPG – Optimised Physiological Gait – function and its sub-functions make it possible for the first time to create a virtually natural physiological gait pattern. Walking up stairs step-over-step without an active drive system, naturally crossing obstacles and relaxed standing are also possible.

Thanks to the new X-Soft adjustment software, the system can even aid in its own customisation for individual users, helping to ensure that the all of its benefits can be utilised.



646D594 Genium Information for Users

647G573 Instructions for Use

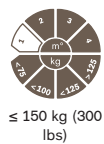

Article number	3B1	3B1=ST
Mobility grade	2, 3, 4	
Material	Carbon	
Proximal connection	Pyramid Adapter	Threaded connector
Distal connection	Tube clamp	
Knee flexion angle	135 °	
proximal system height to alignment reference point	0 mm	26 mm
Minimum distal system height with AXON 2R20/2R21 Tube Adapter	298 mm/330 mm	
Maximum distal system height with AXON 2R20/2R21 Tube Adapter	514 mm/546 mm	514 mm/546 mm
Weight (without tube adapter)	1.395 g	1.400 g
Max. body weight	150 kg	

AXON Tube Adapter

The tube adapter is supplied in a standard length of 515 mm, and is cut to length by the prosthetist with a pipe cutter.

The correct length of the tube adapter is determined using the X-Soft adjustment software.



Article number	2R20	2R21
Material	Aluminium	
Weight	290 g	530 g
Design	Standard	Torsion unit
Max. body weight	150 kg	125 kg

1

2

3



4X1 X-Soft – Auto-Adaptive Software

The Genium Bionic Prosthetic System: as individual as your customers. Nevertheless, selecting the right components and performing the alignment are relatively straightforward for you. Computer-assisted alignment (CAA) allows you to fully utilise the functions of the system in the course of prosthesis alignment: a software program (X-Soft) calculates and visualises the forces acting on the prosthesis, offering individual recommendations for the custom positioning of the prosthetic components. This is a great advancement, since the alignment and socket connection have a major impact on the functionality of a prosthesis. You can't get any more customised.

Article number	4X1
-----------------------	------------

4

5

6



 646D225

60X5 BionicLink PC

The BionicLink PC 60X5 supports wireless data communication between Ottobock products with a Bluetooth® interface (e. g. Dynamic Arm®) and a PC with USB port or USB hub.

The BionicLink PC is equipped with 2 LEDs. The green LED indicates that the device is ready for use. The blue LED indicates that a proper connection has been established between the product and the PC.

A proper connection between the Ottobock product and a PC can only be established using corresponding Ottobock software products (e.g. ElbowSoft).

Article number	60X5
for	Connection to the computer (USB Bluetooth™ adapter)

7

8

9



10

11



12

13

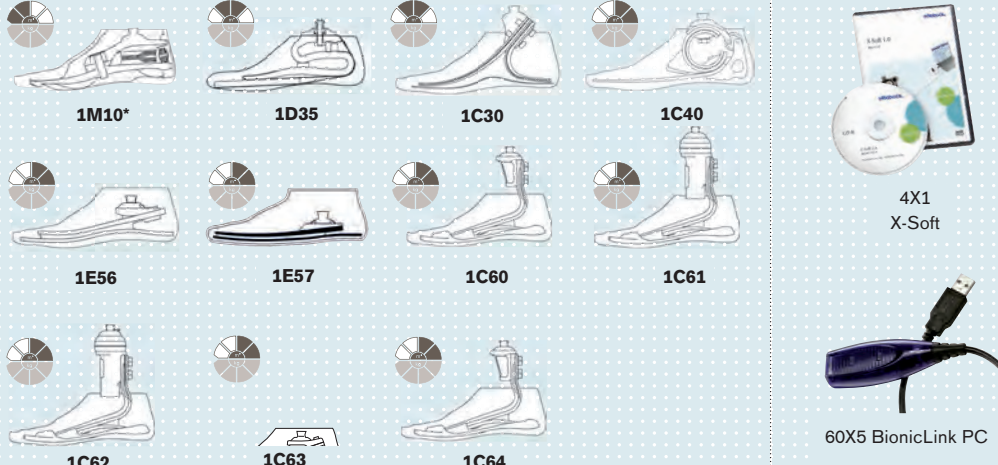
14

Adapter		Inductive charger/ power supply
Genium knee joint/remote control	<p>with pyramid adapter with threaded connector</p> 	Installation ring and tool for inductive charger
AXON Tube Adapter		Installation ring and tool for inductive charger
Prosthetic Foot		BionicLink PC/X-Soft

Information:

-  647G573 Instructions for Use
-  646D428 Patient Information

1
2
3
4
5
6
7
8
9
10
11
12
13
14

1

2

3

4

5

6

7

8

9

10

11

12

13

14



Modular Hip Joints

Thanks to our modular system, prosthetic fittings for various amputations in the hip region such as the intertrochanter amputation, hip disarticulation and hemipelvectomy have been significantly improved. However, fabricating and fitting a prosthesis for these amputation levels remains one of the major challenges faced by orthopaedics technology.

Various hip components are offered for mobility grades 1-3.

An overview of the combinations with suitable knee and foot components can be found on pages 32-33

1

2

3

4

5

6

7

8

9

10

11

12

13

14

1

2

3

4

5

6

7



647H466

7E5 Modular Monocentric Hip Joint with Lock

The hip joint is attached with screws to the pelvic socket lamination plate by the double hinged plate. The built-in manual lock automatically engages in the full extension position. For sitting down, it may be disengaged using a lever. Flexion and extension are adjusted by sliding the extension stop bumper on the tube. Hip rotation is adjustable.

Order example

Reference number	=	Side
7E5	=	L



Reference number	7E5
Mobility grade	1
Material	Aluminum
Proximal connection	Lamination Plate
Distal connection	Tube Ø 30 mm
Side	Left (L), Right (R)
Min. system height	170 mm
Max. system height	360 mm
Flexion angle	120 °
Weight	890 g
Max. body weight	100 kg

8

9

10

11

12

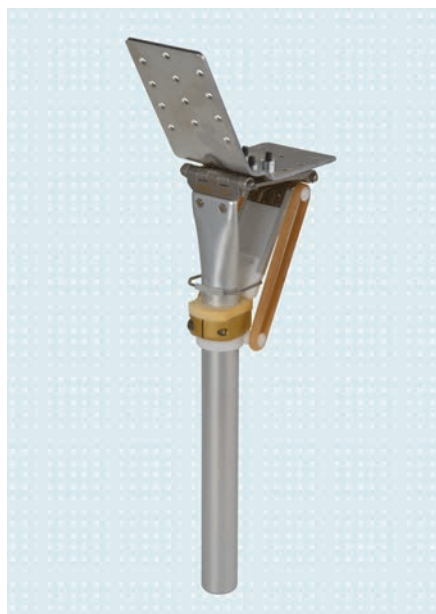

647H466

7E4 Modular Monocentric Hip Joint with Extension Assist

Very similar in design to the 7E5 Modular Hip Joint but without a lock. Instead, the joint has an extension assist with laterally attached latex bands for stride control. Built-in extension stop bumper is adjustable. The extension assist limits the range of motion when walking.



Article number	7E4
Mobility grade	2
Material	Aluminum
Proximal connection	Lamination Plate
Distal connection	Tube Ø 30 mm
Min. system height	170 mm
Max. system height	360 mm
Flexion angle	120 °
Weight	940 g
Max. body weight	100 kg

13

14

Single Components for 7E5 and 7E4 as Spare Parts

Single components pack

Article number	7D5	7D4
for	7E5	7E4
Consisting of	4 lock rings 1 wire bow with plastic roller 1 stop 4 countersunk head screws 2 guide pins 1 complete posterior strut	4 lock rings 1 distal slide control anchor 1 wire bow with plastic roller 1 proximal slide control anchor 1 stop 2 hip extensors 4 countersunk head screws 1 complete posterior strut

7E7 Modular Monocentric Hip Joint with Internal Extension Assist

The upper section of the hip joint is connected to the socket through the lamination plate. It is connected to the lower section through the hip axis. The continuously adjustable extension assist is located in the joint's lower section. It limits the range of motion while walking. The joint features a low structural height (= laminate thickness), which helps to minimise pelvic tilt while the patient is sitting. Abduction/adduction and flexion/extension as well as rotation are continuously adjustable.

The joint is supplied with a 7Z58 Lamination Dummy.



Article number	7E7
Mobility grade	2 + 3
Material	Titanium
Proximal connection	Lamination Plate
Distal connection	Tube Ø 30 mm
Min. system height	95 mm
Max. system height	360 mm
Flexion angle	130 °
Weight	875 g
Max. body weight	100 kg



 647G130

1
2
3
4
5
6
7
8
9
10
11
12
13
14

1
2
3
4
5
6
7
8
9
10
11
12
13
14

Accessories for 7E5/7E4 and 7E7

• Order separately as necessary.



647H9



4R56 Tube Clamp Adapter, with 10°, 20° or 30° angle

The adapter is available with 3 different angles.

In prosthetic fittings with 7E5, 7E4 or 7E7 Hip Joints, it forms the adjustable connection between the pyramid adapter of the knee joint or the 4R57 Rotation Adapter and the hip joint tube. According to the direction of the tube, it forms an angle of 10°, 20° or 30° with the hip joint offset to the front.

In prosthetic fittings with Helix^{3D} Hip Joint System, the adapter is intended for the adjustable proximal connection of the hip joint to the 2R30 Thigh Tube and for the adjustable distal connection of the 2R30 Thigh Tube to the pyramid adapter of the knee joint or the 4R57 Rotation Adapter.



Article number	4R56	4R56=1	4R56=2
Diameter	30 mm		
Material	Titanium		
System height	34 mm		35 mm
Weight	85 g		100 g
Angling	10 °	20 °	30 °
Max. body weight	100 kg		

• The 4R56=1/=2 Tube Clamp Adapter with a 20°/30° angle is recommended for larger pelvic sockets. When using '=HD' knee joints, please consider the 10° angle of the pyramid adapter.



4R32 Finishing Kit for Modular Hip Disarticulation Prostheses

The finishing kit is used to secure the foam connection plate to the pelvic socket and is a functional component of the Ottobock modular hip joints.

Article number	4R32
Consisting of	2 connecting straps with ring 2 distal anchor rings 2 wedges 1 ThermoLyn Trolene strip (as lamination template) 1 pair nylon cosmetic stockings, skin colour, size 3

7Z53 Lamination Plate



Reference number	7Z53
Material	Aluminum
Max. body weight	100 kg

Single Components for 7E7 as Spare Parts

7D2 Single components pack

Article number	7D2
for	7E7
Consisting of	1 tappet 1 guide sleeve 1 extension assist spring 1 safety plate 1 oval head countersunk screw 1 stop 2 cap screws, M8 thread 1 cap screw, M5 thread 1 lock ring 1 protective sleeve (plastic)

1

2

3

4

5

6

7

8

9

10

11

12

13

14

1
2
3
4
5
6
7
8
9
10
11
12
13
14



7E9 Monocentric hip joint with hydraulic control unit

A high-performance miniature hydraulic system forms the heart of the 7E9 Hip Joint, harmoniously damping joint movements in both the swing and the stance phase with the goal of allowing the prosthesis wearer to achieve a gait pattern that comes closer to the physiological model. Combined with the Genium and C-Leg mechatronic knee joint systems, the 7E9 delivers optimum fitting results. A fitting with the 3R60 or 3R106 mechanical knee joint is supported as well. Thanks to the flexible mating part combination possibilities and the high patient weight limit of 125 kg, the hip joint is suitable for a large group of users with hip disarticulation or hemipelvectomy.



Article number	7E9
Mobility grade	2 + 3
Material	Aluminium
Proximal connection	Lamination Anchor
Distal connection	Pyramid Adapter
System height	81 mm
Flexion angle	130 °
Weight	ca. 695 g
Scope of Delivery	7Z53 Lamination Plate (aluminium, up to 100 kg) 7Z253=1-M10 Lamination Plate (steel, up to 125 kg) Connection Technique (proximal)
Max. body weight	125 kg



Hydraulic control of the entire gait cycle

The powerful linear hydraulic system controls the movement of the joint in the stance and swing phase, resulting in an approximation of the natural gait pattern. Dampened and therefore controlled heel strike in the stance phase significantly reduces hyperlordosis and provides for smoother extension of the hip joint.

The pendulum movements in the swing phase are harmoniously controlled across a wide range of walking speeds.

Comfortable sitting thanks to low structural height

The flexion angle of 130° and the low structural height after installation reduce pelvic obliquity in the seated position to a minimum. Sitting is perceived as comfortable and strain on the cosmetic cover is reduced. The large flexion angle also provides relief in everyday situations such as putting on shoes or getting into a car.

Alignment and adjustments made easy

The resistance to movement can be adjusted separately in the stance and swing phases using the supplied tools (see photo).

Scope of Delivery

7Z53 Lamination Plate



Reference number	7Z53
Material	Aluminum
Max. body weight	100 kg

7Z53=1-M10 Lamination Plate



Article number	7Z53=1-M10
Material	Steel
Max. body weight	125 kg

Accessories for 7E9

743A29 Reference Determination Tool

Article number	743A29
-----------------------	---------------

4R52 Tube Clamp Adapter



Article number	4R52
Diameter	30 mm
Material	Titanium
System height	33 mm
Weight	75 g
Max. body weight	100 kg



647H90

- For higher loads in transtibial prostheses, a tube clamp adapter with \varnothing 34 mm should be used (e.g. 4R82/4R91).

1
2
3
4
5
6
7
8
9
10
11
12
13
14



647H9



4R56 Tube Clamp Adapter, with 10°, 20° or 30° angle

The adapter is available with 3 different angles.

In prosthetic fittings with 7E5, 7E4 or 7E7 Hip Joints, it forms the adjustable connection between the pyramid adapter of the knee joint or the 4R57 Rotation Adapter and the hip joint tube. According to the direction of the tube, it forms an angle of 10°, 20° or 30° with the hip joint offset to the front.

In prosthetic fittings with Helix^{3D} Hip Joint System, the adapter is intended for the adjustable proximal connection of the hip joint to the 2R30 Thigh Tube and for the adjustable distal connection of the 2R30 Thigh Tube to the pyramid adapter of the knee joint or the 4R57 Rotation Adapter.



Article number	4R56	4R56=1	4R56=2
Diameter	30 mm		
Material	Titanium		
System height	34 mm		35 mm
Weight	85 g		100 g
Angling	10 °	20 °	30 °
Max. body weight	100 kg		

- The 4R56=1/=2 Tube Clamp Adapter with a 20°/30° angle is recommended for larger pelvic sockets. When using '=HD' knee joints, please consider the 10° angle of the pyramid adapter.



647G748

4R156 Tube Clamp Adapter, with 10°, 20° or 30° angle

The adapter is available with 3 different angles.

Due to its high load-bearing capacity, it is preferable for use in combination with the 7E9 Hip Joint. Here the adapter is intended for the adjustable proximal connection of the hip joint to the 2R36 Thigh Tube and for the adjustable distal connection of the 2R36 Thigh Tube to the pyramid adapter of the knee joint or the 4R57 Rotation Adapter.



≤ 150 kg

Article number	4R156	4R156=1	4R156=2
Diameter	34 mm		
Material	Titanium		
System height	36 mm	37 mm	38 mm
Weight	140 g	165 g	175 g
Angling	10 °	20 °	30 °
Max. body weight	150 kg		

- The 4R156=1/=2 Tube Clamp Adapter with a 20°/30° angle is recommended for larger pelvic sockets. When using '=HD' knee joints, please consider the 10° angle of the pyramid adapter.

4R57 Rotation Adapter

Through incorporation of the rotation adapter above the knee joint, the lower leg may be rotated medially or laterally relative to the socket with the knee flexed.

For the amputee, this mainly translates into enhanced safety. The prosthesis can be swung to the side while driving. This minimises the risk of the prosthetic foot becoming stuck in the area of the pedals. The pedals can be operated using the other leg with no restrictions. In addition, this function allows the amputee to sit in a more comfortable and relaxed position behind the wheel, improving the focus on driving.

Furthermore, the rotation adapter means enhanced comfort for the amputee. It makes everyday activities such as putting on shoes and changing socks easier and allows the amputee to sit comfortably. The sitting position can be varied up to sitting cross-legged. The rotating mechanism is activated through pressing of the release button and is locked automatically.

There are two available versions which have the same function, but differ in terms of the proximal connection:

- Rotation adapter with pyramid adapter and pyramid receiver: the 4R57 Rotation Adapter is equipped with a proximal pyramid adapter.
- Rotation adapter with threaded connector and pyramid receiver: the 4R57=ST Rotation Adapter is equipped with a proximal thread. This allows for particularly space-saving integration of the adapter which can be screwed into the 4R111=N Lamination Anchor or the 4R43 Lamination Anchor.



≤ 150 kg

Article number	4R57
Material	Stainless steel
Proximal connection	Pyramid Adapter
Distal connection	Pyramid Receiver
System height	22 mm
Weight	170 g
Rotation	max. 360° (without foam cover)
Max. body weight	150 kg

- In order for the 4R57=ST Rotation Adapter to be able to be screwed properly into the lamination anchor, the 4X46=ST Lamination Dummy must be used for laminating. It must be ordered separately (see accessories Page 169).
- The 4R57 cannot be combined with the 2R49, 2R50 or 4R95.



647G258



1

2

3

4

5

6

7

8

9

10

11

12

13

14

2R30 Light Metal Tube

Article number	2R30
Diameter	30 mm
Max. body weight	up to 100 kg

1

2R36 Light Metal Tube

2

Article number	2R36
Diameter	34 mm
for	4R156=* Angled Tube Clamp Adapter
Max. body weight	up to 125 kg

3

4

5

6

7

8

9

10

11

12

13

14

	1
	2
	3
	4
	5
	6
	7
	8
	9
	10
	11
	12
	13
	14

1
2
3
4
5
6
7
8
9
10
11
12
13
14



647G387
647G550



reddot design award
winner 2008

7E10 Helix^{3D} Hip Joint

The Ottobock brand stands for trendsetting innovations in prosthetics. The new Helix^{3D} Hip Joint System also is a trendsetter. It sets new standards for safety, dynamics and comfort, redefining mobility for persons with a hip disarticulation or hemipelvectomy.

The Helix^{3D} Hip Joint has been tested and approved exclusively for combination with the C-Leg and Genium knee joints and the corresponding system components.



Reference number	7E10
Mobility grade	2 + 3
Material	Aluminum
Proximal connection	Lamination Plate
Distal connection	Pyramid Adapter
System height	146 mm
Flexion angle	130 °
Weight	990 g
Max. body weight	100 kg

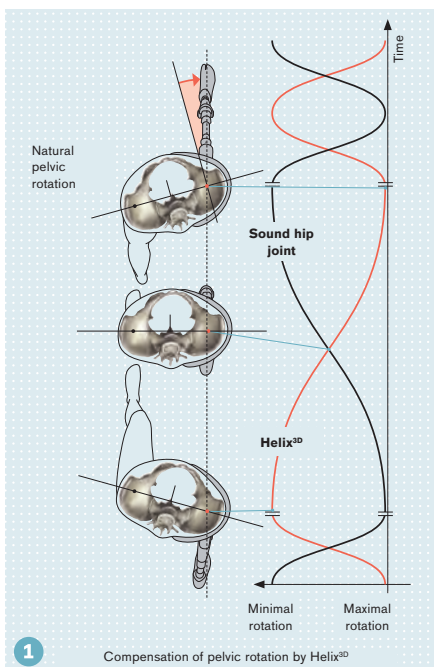

The patented multi-axis joint structure

- produces a three-dimensional hip movement to compensate for pelvic rotation and promotes a symmetrical and natural gait pattern. (Fig. 1)
- allows for leg length reduction during the swing phase with the aim to reduce the risk of falling and thereby to increase functional safety.
- ensures optimal sitting characteristics and reduces pelvic obliquity to a minimum.
- makes a large flexion angle possible, to facilitate everyday situations like putting on shoes or getting into a car.

The novel spring-hydraulics combination

- supports initiation of the swing phase by the prosthesis wearer with integrated expansion springs. Energy stored during the stance phase is used to compensate for the lack of hip musculature during swing phase initiation and to reduce the amount of energy needed for walking. (Fig. 2)
- controls the three-dimensional movement during the entire step cycle.
- allows for dampened, controlled heel strike in the stance phase with significantly reduced hyperlordosis as well as harmonious hip joint extension. Controlled and smooth rollover on the prosthesis under full load becomes possible.
- allows for individual stride length setting and to control the pendulum motion in the swing phase.



Indication and Area of Application

The Helix^{3D} Hip Joint System is suitable for hip disarticulation and hemipelvectomy amputees. It offers amputees of all age groups maximum safety and comfort for a wide range of everyday activities. Recommended according to MOBIS, the Ottobock Mobility System for amputees with mobility grade 2 and 3 (restricted outdoor walkers, unrestricted outdoor walkers).

Max. body weight: 100 kg

Helix^{3D} – Systematic Fitting







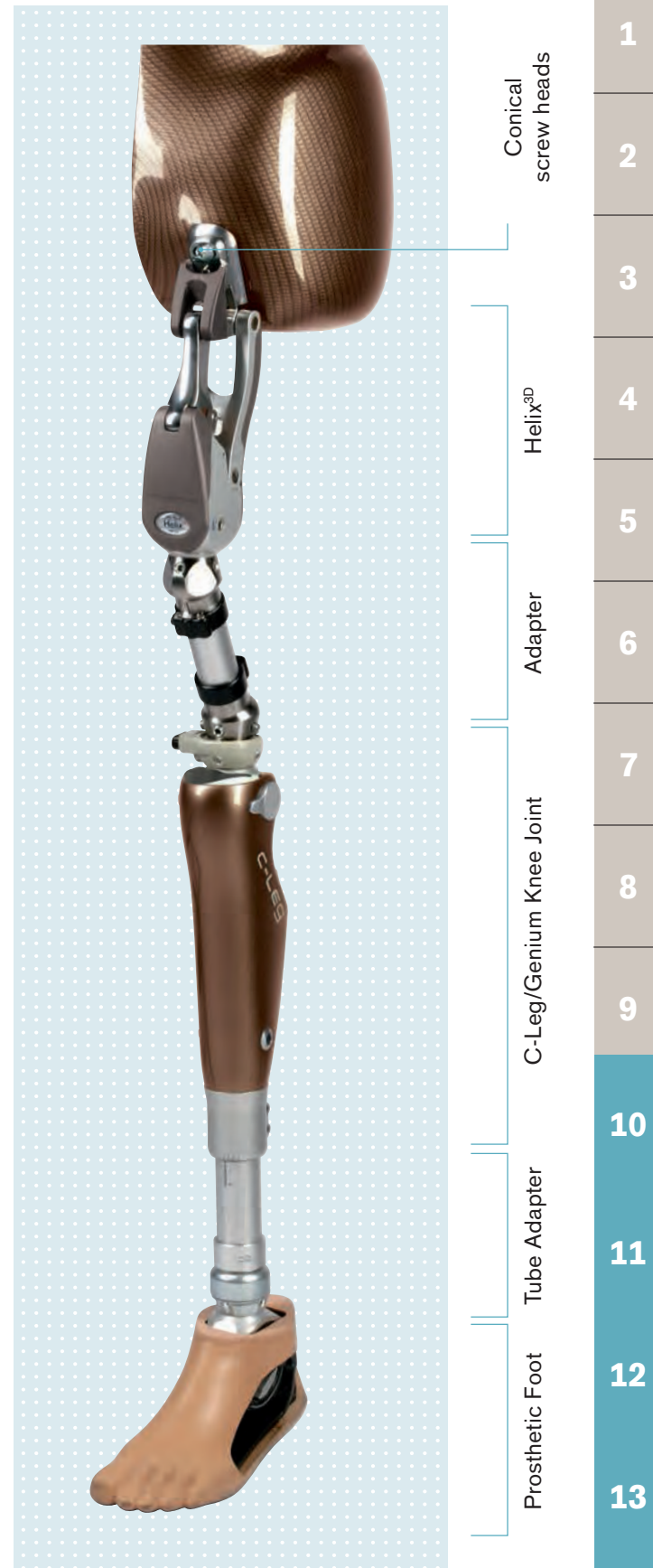











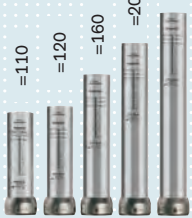

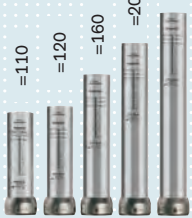

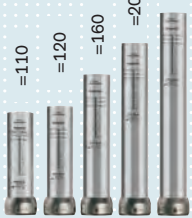

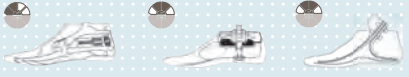





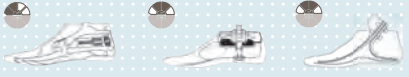

The functions of the Helix^{3D} Hip Joint are especially adapted to the characteristics of selected Ottobock components. This allows the advantages of the individual components to be fully realised.

Are you already a C-Leg certified prosthetist? Are you also interested in carrying out professional patient fittings with the new Helix^{3D} Hip Joint? Then you and your patient should attend our certification workshop. This workshop is a prerequisite for carrying out independent fittings with the Helix^{3D} Hip Joint System.

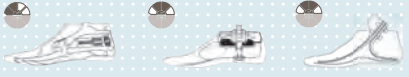
If you have any questions, please contact your local Ottobock branch.



Accessories for 7E10

1								
2								
3	Helix ^{3D} Hip Joint	 <p>7E10=L-1.2 7E10=R-1.2</p>						
4	Adapter	 <p>743A29 4R52 4R56 4R56=1 4R56=2 4R57 2R30</p>						
5								
6	Knee Joint	<table border="0"> <tr> <td style="text-align: center;"> <p>C-Leg</p>  <p>4X160=1.2 4X160=5.6 3C98-2 C-Leg 3C98-2=7.1 C-Leg Carbon Black Metallic</p> </td> <td style="text-align: center;"> <p>Genium</p>  <p>3B1 Genium</p> </td> </tr> </table>	<p>C-Leg</p>  <p>4X160=1.2 4X160=5.6 3C98-2 C-Leg 3C98-2=7.1 C-Leg Carbon Black Metallic</p>	<p>Genium</p>  <p>3B1 Genium</p>				
<p>C-Leg</p>  <p>4X160=1.2 4X160=5.6 3C98-2 C-Leg 3C98-2=7.1 C-Leg Carbon Black Metallic</p>	<p>Genium</p>  <p>3B1 Genium</p>							
7								
8								
9	Tube Adapter	<table border="0"> <tr> <td style="text-align: center;"> <p>2R82=* =110 =120 =160 =200 =240</p>  </td> <td style="text-align: center;"> <p>2R81=* =160 =200 =240</p>  </td> <td style="text-align: center;"> <p>2R20 2R21</p>  </td> </tr> </table>	<p>2R82=* =110 =120 =160 =200 =240</p> 	<p>2R81=* =160 =200 =240</p> 	<p>2R20 2R21</p> 			
<p>2R82=* =110 =120 =160 =200 =240</p> 	<p>2R81=* =160 =200 =240</p> 	<p>2R20 2R21</p> 						
10								
11	Prosthetic Feet	<table border="0"> <tr> <td style="text-align: center;">  <p>1M10 1A30 1C30</p> </td> <td style="text-align: center;">  <p>1M10 1D35 1C30</p> </td> </tr> <tr> <td style="text-align: center;">  <p>1D35 1C40 1E56</p> </td> <td style="text-align: center;">  <p>1C40 1E56 1E57</p> </td> </tr> <tr> <td style="text-align: center;">  <p>1E57 1C60 1C61</p> </td> <td style="text-align: center;">  <p>1C60 1C61</p> </td> </tr> </table>	 <p>1M10 1A30 1C30</p>	 <p>1M10 1D35 1C30</p>	 <p>1D35 1C40 1E56</p>	 <p>1C40 1E56 1E57</p>	 <p>1E57 1C60 1C61</p>	 <p>1C60 1C61</p>
 <p>1M10 1A30 1C30</p>	 <p>1M10 1D35 1C30</p>							
 <p>1D35 1C40 1E56</p>	 <p>1C40 1E56 1E57</p>							
 <p>1E57 1C60 1C61</p>	 <p>1C60 1C61</p>							
12								
13								
14								

7Z53 Lamination Plate



Reference number	7Z53
Material	Aluminum
Max. body weight	100 kg

646DV55 Gate training DVD

Article number	646DV55
-----------------------	----------------



1

2

3

4

5

6

7

8

9

10

11

12

13

14

1

2

3

4

5

6

7

8

9

10

11

12

13

14



Socket Technologies

Ottobock Socket Technologies ensure that a highly individual part of the prosthesis, the section that is in direct contact with the residual limb, is adapted to the user and his or her specific requirements. To ensure a high level of safety and wearer comfort, we offer a large selection of liner materials and suspension system for the prosthetic socket.

Ottobock is the only supplier in the world that gives the option of selecting the best possible liner for the user from the three materials of silicone, copolymer and polyurethane. Each of the three liner materials has unique characteristics. In combination with the corresponding suspension system, the right material ensures the user's residual limb is securely connected to the prosthesis.

1
2
3
4
5
6
7
8
9
10
11
12
13
14

Silicone Liners			
General Information	Indications		Measuring Example
<ul style="list-style-type: none"> • Ideal for use in combination with the shuttle lock system • Extremely durable • Easy to clean 	<ul style="list-style-type: none"> • Residual limbs with a good covering of soft tissue • Low to medium activity level • Use specific weight bearing socket design 	<p>The diagram shows a cross-section of a silicone liner. A dashed horizontal line indicates the 'Distal circumference' measurement point. A vertical double-headed arrow below it indicates a '4 cm' distance from the distal circumference to the bottom edge of the liner.</p>	<p>Measure distal circumference, select next smaller liner size</p>
Copolymer Liners			
General Information	Indications		Measuring Example
<ul style="list-style-type: none"> • Ideal for use in combination with a valve and sealing sleeve • User and prosthetist-friendly • Offers good protection against socket forces 	<ul style="list-style-type: none"> • Many residual limb types; especially residual limbs with dry skin • Low to medium activity level • Use total surface weight bearing socket 	<p>The diagram shows a cross-section of a copolymer liner. A dashed horizontal line indicates the 'Distal circumference' measurement point. A vertical double-headed arrow below it indicates a '4 cm' distance from the distal circumference to the bottom edge of the liner.</p>	<p>Measure distal circumference, select next smaller liner size</p>
Polyurethane Liners			
General Information	Indications		Measuring Example
<ul style="list-style-type: none"> • Ideal for use with an exhaust valve and sealing sleeve or with the Harmony system • Offers very good protection against socket forces • Flow characteristics maintains a precise, comfortable fit 	<ul style="list-style-type: none"> • All residual limb types, especially sensitive, bony and/or scarred residual limbs • Low to high activity level • Use total surface weight bearing socket according to Harmony principle 	<p>The diagram shows a cross-section of a polyurethane liner. A dashed horizontal line indicates the 'Distal circumference' measurement point. A vertical double-headed arrow below it indicates a '4 cm' distance from the distal circumference to the bottom edge of the liner.</p>	<p>Measure distal circumference, select next smaller liner size</p>

TransTibial SIL Liner with SKINGUARD Technology

The 6Y75 TransTibial SIL Liner with SKINGUARD Technology contains a new and effective additive. The high-tech functionality of the antibacterial additive protects the liner against bacteria and therefore against unpleasant odours.

The 6Y75 TransTibial SIL Liner with SKINGUARD Technology offers:

- Antibacterial additive
- Soft silicone with a silky, skin-friendly interior
- Effective system to reduce distal elongation without affecting circumferential stretching
- Extremely smooth and durable silver textile cover
- Soft distal cap

The innovative 6Y75 liner and the proven 6Y70 are suitable for users with low to moderate activity levels who are looking for a durable but soft silicone material.

Order example

Reference number	=	Size
6Y75	=	280

Reference number	6Y75
Connection	with distal connection, with SkinGuard Technology
Wall thicknesses	from approx. 5 mm distally, tapering to 3 mm proximally
Size (distal circumference)	160 mm, 180 mm, 200 mm, 210 mm, 220 mm, 235 mm, 250 mm, 265 mm, 280 mm, 300 mm, 320 mm, 340 mm, 360 mm, 380 mm, 400 mm

Order example

Reference number	=	Size	-	Wall thickness
6Y70	=	280	-	6

Reference number	6Y70
Connection	with distal connection; without SkinGuard Technology
Wall thicknesses	3 mm (-), 6 mm (6), tapering from approx. 5 mm distal to 3 mm proximal/6 mm uniform
Size (distal circumference)	160 mm, 180 mm, 200 mm, 210 mm, 220 mm, 235 mm, 250 mm, 265 mm, 280 mm, 300 mm, 320 mm, 340 mm, 360 mm, 380 mm, 400 mm

• Custom sizes are also available.

6Y70 Liner Special order only.



SIL

1
2
3
4
5
6
7
8
9
10
11
12
13
14

1

2

3

4

5

6

7

8

9

10

11

12

13

14



SIL

6Y42 Standard Pro SIL Liner

The 6Y42 Standard-Pro SIL liner is a durable, thin-walled silicone liner with a distal connection. It also features a textile coating, making the liner easy to put on and take off without using a donning spray.

Longitudinal stretching and pistoning are minimised thanks to the integrated distal matrix (10 cm). This protects the sensitive residual limb ends.

The 6Y42 Standard Pro SIL Liner is suitable for users with a low to moderate activity level and good soft tissue coverage on their residual limb.

Order example

Reference number	=	Size
6Y42	=	280

Reference number	6Y42
Wall thicknesses	from approx. 4.5 mm distally, tapering to 2.5 mm proximally
Size (distal circumference)	180 mm, 200 mm, 210 mm, 220 mm, 235 mm, 250 mm, 265 mm, 280 mm, 300 mm, 320 mm, 340 mm, 360 mm, 380 mm, 400 mm, 420 mm, 450 mm

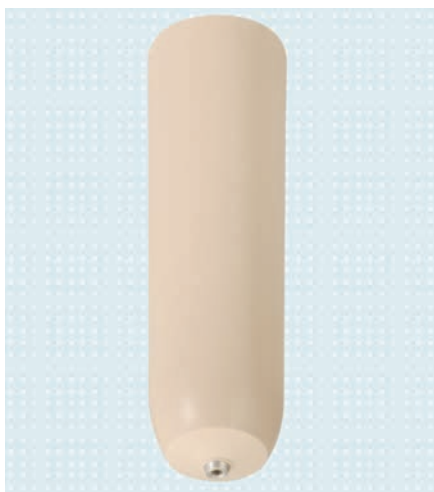

SIL

6Y40 Basic SIL Liner

The 6Y40 Basic SIL Liner for basic or initial fittings is a durable, thin-walled silicone liner with distal connection and without textile cover. This makes it suitable for waterproof walking aids.

Longitudinal stretching and pistoning are minimised thanks to the integrated distal matrix (10 cm). This protects the sensitive residual limb ends.

A donning spray (640F18) can be used.

The 6Y40 Basic SIL Liner is suitable for users with a low to moderate activity level and good soft tissue coverage on their residual limb.

Order example

Reference number	=	Size
6Y40	=	280

Reference number	6Y40
Connection	with distal connection
Wall thicknesses	from approx. 4.5 mm distally, tapering to 2.5 mm proximally
Size (distal circumference)	120 mm, 140 mm, 160 mm, 180 mm, 200 mm, 210 mm, 220 mm, 235 mm, 250 mm, 265 mm, 280 mm, 300 mm, 320 mm, 340 mm, 360 mm, 380 mm, 400 mm, 420 mm, 450 mm

- Use in waterproof walking devices only in combination with the 6A30=20 Shuttle Lock
- 6Y40 Liner special order only.

ProSeal System

6Y81 ProSeal SIL Liner

The 6Y81 ProSeal SIL Liner is a special, durable silicone liner for transfemoral vacuum socket fittings.

ProSeal ring technology can be used in transfemoral applications with this liner. The special, smooth exterior coating makes application and removal of the liner easy.

The 6Y81 ProSeal SIL Liner is suitable for transfemoral amputees with a moderate to high activity level.

Order example

Reference number = Size

6Y81 = 300

Reference number	6Y81	
Connection	without distal connection	without distal connection (without blind cap)
Wall thicknesses	3 mm	
Size (distal circumference)	280 mm, 300 mm, 320 mm, 340 mm, 360 mm, 380 mm, 400 mm, 420 mm, 450 mm, 500 mm, 550 mm,	



SIL

452A1 ProSeal Ring

Proximal sealing system for TF vacuum sockets.

Recommended in combination with the 6Y81 ProSeal SIL Liner.

Order example

Reference number = Proximal circumference

452A1 = 320

Reference number	452A1															
Size	320	340	360	380	400	420	440	460	480	500	520	540	560	580	600	640
Proximal circumference	320 mm, 340 mm, 360 mm, 380 mm, 400 mm, 420 mm, 440 mm, 460 mm, 480 mm, 500 mm, 520 mm, 540 mm, 560 mm, 580 mm, 600 mm, 640 mm															
Scope of Delivery	Sealing ring, fixation ring, lamination dummy															



647G597



1

2

3



SIL

4

5

6

7

8

9

10

11

12

13

14

TransFemoral SIL Liner with SKINGUARD Technology

The 6Y85 TransFemoral SIL Liner with SKINGUARD Technology with distal connection contains a new and effective additive. The high-tech functionality of the antibacterial additive protects the liner against bacteria and therefore against unpleasant odours.

Thanks to its high transverse elasticity, the liner adapts to the shape of the residual limb. The integrated, interior textile matrix prevents elongation and pistoning for superior safety and control. Circumferential stretching is not affected.

The new, silky and skin-friendly interior effectively reduces friction between the liner and skin – especially in the area of the perineum.

The 6Y85 and 6Y80 liners are suitable for transfemoral amputees with a low to moderate activity level.

Order example

Reference number	=	Size
------------------	---	------

6Y85	=	300
------	---	-----

Reference number	6Y85
Connection	with distal connection, with SkinGuard Technology
Wall thicknesses	from approx. 4.5 mm distally, tapering to 2.5 mm proximally
Size (distal circumference)	280 mm, 300 mm, 320 mm, 340 mm, 360 mm, 380 mm, 400 mm, 420 mm, 450 mm, 500 mm, 550 mm

Order example

Reference number	=	Size
------------------	---	------

6Y80	=	300
------	---	-----

Reference number	6Y80
Connection	with distal connection
Wall thicknesses	from approx. 4.5 mm distally, tapering to 2.5 mm proximally
Size (distal circumference)	280 mm, 300 mm, 320 mm, 340 mm, 360 mm, 380 mm, 400 mm, 420 mm, 450 mm, 500 mm, 550 mm

- Custom sizes are also available.
- **6Y80 Liner special order only.**

6Y512 Anatomic 3D PUR Liner

The Anatomic 3D PUR liner is based on the anatomy of the lower leg. Thanks to innovative ASG (anatomy-specific geometry) technology, the liner sets new protection standards. The polyurethane material ensures optimum pressure distribution and durability. A special structure distributes moisture in the liner during use so it literally disappears in the texture. The Anatomic 3D PUR Liner is available with the antibacterial additive SkinGuardTechnology.

Size selection:

- Measure the length from MPT to the distal end of the residual limb to determine residual limb length.
- Measure the circumference 40 mm from the distal end of the residual limb to determine residual limb circumference.
- Select the article number in the table according to the measurements taken.
- The proximal circumference 100 mm above the MPT can be used to check the fit on the thigh. This helps you decide whether a standard liner will fit or whether to use a custom liner. Compare the measurement in the right column with the previously determined proximal circumference.

Order example

Reference number	=	Residual limb circumference	x	Residual limb length	(-F: with textile) (-G: with SKINGUARD®Technology)
6Y512	=	210	x	175	(-F)(-G)

Reference number	6Y512
------------------	--------------

➤ Please select the model here as well (textile: none or partial (-F)).



PUR

Residual limb length (in mm) MPT (mid-patella tendon) to distal end	Residual limb circumference (in mm) 40 mm above distal end																				Proximal circumference (in mm) 100 mm above MPT (mid-patella tendon) (for verification only)				
	215	220	225	230	235	240	245	250	255	260	265	270	275	280	285	290	295	300	305	310		315	320	325	330
50 – 100	6Y512=250x75 (-F)(-G)																		305 – 370						
100 – 150	6Y512=210x125 (-F)(-G)																				290 – 340				
	6Y512=235x125 (-F)(-G)																				305 – 370				
	6Y512=265x125 (-F)(-G)																				330 – 390				
150 – 200	6Y512=280x125 (-F)(-G)																				360 – 430				
	6Y512=300x125 (-F)(-G)																				380 – 440				
	6Y512=210x175 (-F)(-G)																				290 – 340				
150 – 200	6Y512=235x175 (-F)(-G)																				305 – 370				
	6Y512=265x175 (-F)(-G)																				330 – 390				
	6Y512=280x175 (-F)(-G)																				360 – 430				
	6Y512=300x175 (-F)(-G)																				380 – 440				

1

2

3

4



PUR

5

6

7

8

9

10

11

12

13

14

6Y510 Profile PUR Liner

The 6Y510 Profile PUR Liner is a preflexed, skin-friendly polyurethane liner with flow characteristics providing good pressure distribution and high shock absorption.

It is designed specifically for transtibial amputees and available in three lengths (knee centre to distal end 75 mm, 125 mm and 175 mm).

Integrated flexion makes it easier to bend the knee.

The 6Y510 Profile PUR Liner is suitable for users with a low to high activity level.

Order example

Reference number	=	Size	x	Residual limb length	-	Textile cover
6Y510	=	300	x	125	-	5

Reference number	6Y510		
Connection	without distal connection		
Wall thicknesses	approx. 6 mm to knee centre, tapering to 3 mm from knee centre		
Plaster cast technique	Full weight bearing socket		
Residual limb length (from knee centre)	75 mm	125 mm	175 mm
Circumference (4 cm from distal)	175 mm, 200 mm, 225 mm, 250 mm, 275 mm, 300 mm, 325 mm	210 mm, 235 mm, 260 mm, 285 mm, 310 mm	
Textile cover	light blue (5), without textile cover (-)		
Shape	anatomically pre-shaped, good pressure distribution		

⊘ Not available in the US.

Simplicity Tapered PUR Liner

Order example

Reference number = Size - (with SkinGuard® Technology)

6Y522 = 190 - (G)

The Simplicity Tapered PUR Liner is made of special skin-friendly polyurethane featuring excellent flowing characteristics. They ensure optimum pressure distribution and high shock absorption.

For additional protection of the residual limb, we chose a wall thickness of 6 mm in the distal area (up to 10 cm) tapering to 3 mm in the proximal direction.

The Simplicity Tapered PUR Liner is designed for users with a low to moderate activity level.

The Simplicity PUR Liner is available with the SKINGUARD Technology antibacterial additive.

Reference number	6Y522
Connection	without distal connection
Wall thicknesses	6 mm wall thickness up to 10 cm distal, tapering to 3 mm wall thickness proximal
Size (distal circumference)	190 mm, 210 mm, 230 mm, 250 mm, 290 mm, 310 mm
Textile cover	without textile cover (-) ; with SkinGuard Technology (-G)

The Simplicity Tapered PUR Liner is made of special skin-friendly polyurethane featuring excellent flowing properties. They ensure optimum pressure distribution and high shock absorption.

For additional protection of the residual limb, we chose a wall thickness of 6 mm in the distal area (up to 10 cm) tapering to 3 mm in the proximal direction.

The Simplicity Tapered PUR Liner is designed for users with a low to moderate activity level.

The Simplicity PUR Liner is available with the SkinGuard Technology antibacterial additive.

Reference number	6Y523
Connection	without distal connection
Wall thicknesses	6 mm wall thickness up to 10 cm distal, tapering to 3 mm wall thickness proximal
Size (distal circumference)	190 mm, 210 mm, 230 mm, 250 mm, 290 mm, 310 mm
Textile cover	light blue ; with SkinGuard Technology (-G)



PUR

6Y540 AKquire PUR Liner

The 6Y540 AKquire PUR Liner for transfemoral amputees is made of a special, skin-friendly polyurethane featuring excellent flowing properties. They ensure optimum pressure distribution and high shock absorption.

The thin proximal wall thickness (3 mm) allows for a comfortable transition to the socket.

The 6Y540 AKquire PUR Liner is suitable for transfemoral amputees with a low to moderate activity level.

Order example

Reference number = Size

6Y540 = 305

Reference number	6Y540
Connection	without distal connection
Wall thicknesses	from approx. 5 mm distally, tapering to 3 mm proximally
Size (distal circumference)	203 mm, 254 mm, 305 mm, 355 mm, 405 mm, 457 mm, 508 mm



PUR

1

2

3

4

5

6

7

8

9

10

11

12

13

14

1
2
3
4
5
6
7
8
9
10
11
12
13
14



TPE

6Y93 Balance TPE Liner

The 6Y93 Balance TPE Liner is a skin-friendly and easy to apply solution for users with a low to moderate activity level. The soft, flexible, thermoformable material reduces shear forces and pressure while the medical white oil moisturises and regenerates the skin. Various wall thicknesses offer protection with flexibility while keeping the residual limb in balance.

Order example

Reference number	=	Connection	Distal cushion	-	Size
6Y93/6Y93F	=	C	6	-	M

Reference number	6Y93	6Y93=L6
Distal connection	without	with
Exterior coating	with	
Liner length	38 cm	
Distal cushion	6 mm	

The longer 6Y93F Balance TPE Liner version is intended especially for Symes and knee disarticulation amputees. Thanks to the distal cushion with extra reinforcement, highly sensitive residual limbs are protected.

Reference number	6Y93F=C6	6Y93F=L6
Distal connection	without	with
Exterior coating	with	
Liner length	50 cm	
Distal cushion	14 mm	

S, M, L and XL are standard sizes. MP and LP are special sizes for a more conical residual limb shape.

- Measure the circumference at the distal end (4 cm) and the proximal end (30 cm from the distal end).
- Select your size according to the following table.

Size	4 cm from distal end		30 cm from distal end	
	Min.	Max.	Min.	Max.
S	150	260	200	330
M	180	310	230	410
MP	200	310	330	500
L	230	350	360	560
LP	280	430	400	630
XL	330	500	430	690

6Y92 Basic TPE Liner

The 6Y90 and 6Y92 Basic TPE Liners are cylindrical shaped, textile-covered liners made from a thermoformable copolymer. The user-friendly copolymer contains a medical grade mineral oil which helps moisturise dry skin and contains an antioxidant which traps free radicals and hydroxyl groups.

The 6Y90 and 6Y92 Basic TPE Liners are suitable for patients with a low to moderate activity level.

Order example

Reference number = Size

6Y92 = 200

Reference number	6Y92	6Y90
Connection	without distal connection	with distal connection and 10 cm distal matrix
Distal cap	without distal cap	with distal cap
Wall thicknesses	10 mm thick distal cushion pad; wall thickness tapering from 5.5 mm to 2.5 mm proximal	
Size (distal circumference)	200 mm, 250 mm, 280 mm, 320 mm, 360 mm	

🚫 **Not available in the US.**



1

2

3

4

5

6

7

8

9

10

11

12

13

14

- 1
- 2
- 3
- 4
- 5
- 6
- 7
- 8
- 9
- 10
- 11
- 12
- 13
- 14

Custom Liners

Ottobock understands that your patients are unique and present different challenges. Our custom liners are an excellent solution when a personalised fit is needed.

PUR

Custom Polyurethane (PUR) Liners

Every user is unique.

A custom polyurethane (PUR) liner meets these requirements because it is made to order for a specific user. This makes it the perfect solution for anyone requiring a highly individual fitting. It offers you the opportunity to meet the specific needs of the user. Thanks to innovative technology, the custom polyurethane (PUR) liner has numerous advantages:

- Optimised material offers enhanced tear and puncture resistance
 - Flow characteristics that assure excellent pressure distribution are retained
 - High durability thanks to a special surface coating
 - Easy handling for the user
 - Custom fit for all residual limb shapes
 - As an option, custom PUR liners are available with the SkinGuard Technology antibacterial additive
-

6Y400 PUR Custom Liner

Custom PUR liner from cast and measurement form

Article number	6Y400
-----------------------	--------------

6Y414 Harmony Custom Liner (PUR)

Harmony custom liner (PUR) – offers the best liner properties for the Harmony system. Fabricated according to a plaster cast.

Article number	6Y414
-----------------------	--------------

6Y416 ShapePlus Custom PUR Liner

ShapePlus custom PUR liner – for challenging shapes and sizes, such as scarring, undercuts, knee flexion 15 – 35°, large circumferences (≥80cm) or long lengths (MPT to distal end ≥ 30cm), i.e. Symes, knee disarticulations, etc. Fabricated according to a plaster cast.

Article number	6Y416
-----------------------	--------------



PUR

6Y430 PUR Custom Liner for transfemoral fittings

Fabricated according to a plaster cast or submitted check socket.

Article number	6Y430
-----------------------	--------------

1

2

3

4

5

6

7

8

9

10

11

12

13

14

1

SIL

Custom Silicone (SIL) Liners

Our custom silicone liners provide solutions when the situation requires locking liner suspension or added durability. The product range of custom silicone liners extends from versions of our 6Y70 and 6Y80 liners fabricated according to your measurements, to highly versatile and durable custom liners from Silicone Fabrication for unique shapes, e.g. highly conical or in case of scarring, with multiple durometers, undercuts, varied lengths and thicknesses, and when custom colours are desired for a truly personal touch.

2

3

4

6Y70=M Custom Silicone Gel Liner

Article number	6Y70=M
Connection	with distal connection
Not available in the US.	

5

6Y80=M TF Adapt Custom Silicone Liner

Article number	6Y80=M
Connection	with distal connection
Not available in the US.	

6

7

88L Custom Silicone Liner from a plaster cast

Article number	88L
-----------------------	------------

8

6Y81=M-2 ProSeal Custom SIL Liner

Article number	6Y81=M-2
Connection	without distal connection (without blind cap)
Not available in the US.	

9

10

11

12

13

14

453H12 Derma Prevent

- Prevents chafing
- Inhibits contact with external allergens
- Covers highly stressed skin with a protective coating and leaves it soft and supple
- Inhibits perspiration and odour formation through the individual release of an active substance

Article number	453H12	453H12=1
Order by	6 bottles	1 bottle
Contents	100 ml	



Practical recommendation:

- To reduce the static friction of Polytol, rub a thin layer of Derma Prevent on the inside and outside of the socket. Do not apply Derma Prevent to those places where a double sided adhesive strip or a self-adhesive hook or loop strip will be attached later on.

453H10 Derma Clean

- Cleans gently and safely
- Ph-neutral, free of alkali and phosphates
- Anti-bacterial formula

Article number	453H10	453H10=1
Order by	6 bottles	1 bottle
Contents	300 ml	



453H14 Derma Repair

- Moisturises and promotes the regeneration of dry, irritated skin
- Reduces the effects of excessive strain and soothes irritated skin
- Antibacterial formula: helps assist the skin's defence system against harmful environmental effects
- Regulates moisture and makes the skin noticeably more supple and elastic
- Improves skin function, promotes the skin's blood circulation and helps cells to grow

Article number	453H14	453H14=1
Order by	6 bottles	1 bottle
Contents	200 ml	



Accessories

453H30=GB Derma Travel Set

Contains one bottle each of Derma Clean, Derma Prevent and Derma Repair as well as a handy toilet bag.

Article number	453H30=GB
-----------------------	------------------



1

646M453 Derma Trial Set

One small trial bottle each of Derma Clean, Derma Prevent and Derma Repair.

2

Article number

646M453

3

4

5

6

7

8

9

10

11

12

13

14

719S20 Special Scissors for Cutting Synthetic Fabrics

For cutting fabric covered liners. The scissors' special coating is designed to cut through synthetic fibres and ensure effective protection against abrasive wear. The coating makes the scissor blades especially durable. Friction constantly replenishes the ceramic oxide layer. The scissors are resistant against UV and perspiration and extremely corrosion resistant. The very low-friction coating allows the scissors to cut modern high-performance fabrics easily.



Article number	719S20
To be used for	

756L10 Liner Trimmer

For trimming and bevelling the proximal end of gel liners in one process step. The liner trimmer leaves a smooth edge.



Article number	756L10
-----------------------	---------------

640F18 Donning Spray for Silicone Liners

Article number	640F18	640F18=900
Contents	45 ml	900 ml



1

2

3

4

5

6

7

8

9

























10

11

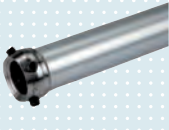
12

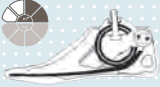
13

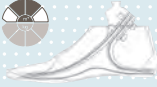
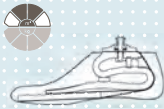
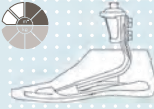
14

1	Sealing Sleeves						
2		453A2 Derma Protection	453A3 Derma ProFlex	453A4 Derma ProFlex, short	454A7 Harmony	454A8 Harmony, conical	
3		<hr/>					
4		Liner					
5			6Y414 Custom Harmony Liner	6Y512 Anatomic 3D PUR Liner	6Y522 Simplicity Tapered Liner		
6	Adapter						
7		4R116	4R77	4R74	4R51	4R55	4R111
8		<hr/>					
9	Harmony						
10		4R152 Harmony E2	4R147 Harmony P3	4R150 Harmony HD	4R144 Harmony P2		
11	Tube Adapter						
12		4R52	4R3	2R57	4R75=D-70	4R84	4R44=L
13	Prosthetic Foot						
14		1C40 C-Walk	1E56 Axtion	1E57 Lo Rider	1C30 Trias		
							
		1D35 Dynamic Motion	1C60 Triton	1C63 Triton Low Profile	1C64 Triton Heavy Duty		

4R147 Harmony P3

“Less is More” was the major goal for the redesign of the mechanical Harmony system in regards to weight, height and complexity.

Development of the Harmony P3 accomplished all these goals. The new, slim pump weighs only 399 g (0.88 lbs), which is a 20% reduction in weight, and also features a reduced system height. This allows more users to benefit from the advantages of the vacuum system.

The core function of the Harmony P3 is provided by a functional ring. It provides the pump function, absorbs vertical shocks and allows for natural rotation. The functional rings can be easily adjusted or exchanged to meet the user's needs. The 3-in-1 functional rings also make it possible to service the Harmony P3 in the field.

- Certification is required to fit the Harmony system.



647H14



Article number	4R147=0	4R147=1	4R147=2	4R147=3	4R147=4	4R147=5	4R147=6	4R147=7
Mobility grade	2 - 4							
Material	Steel, Titanium							
Proximal connection	Pyramid Receiver							
Distal connection	Tube clamp 34 mm							
Size	0	1	2	3	4	5	6	7
Recommended for body weight	40 - 47 kg	48 - 55 kg	56 - 65 kg	66 - 75 kg	76 - 87 kg	88 - 100 kg	101 - 112 kg	113 - 125 kg
System height	95 mm							
Weight	399 g							
Scope of Delivery	Pump with pre-assembled functional ring, plus socket connection and sound absorber							
Max. body weight	125 kg							

4R144 Harmony P2

The Harmon system controls the volume of the residual limb and prevents volume fluctuations. A total surface weight bearing socket is used with polyurethane liner.



Article number	4R144
Mobility grade	2 - 4
Material	Aluminum, Steel
Proximal connection	Pyramid adapter
Distal connection	Tube connection 30 mm
System height	142 mm
Weight	520 g
Max. body weight	100 kg

- Certification is required to fit the Harmony system.



1

2

3

4

5

6

7

8

9

10

11

12

13

14

1
2
3
4
5
6
7
8
9
10
11
12
13
14

Service Parts



4X147 Functional Ring for Harmony P3

Article number	Consisting of	Body weight	Functional ring stiffness
4X147=0	Functional ring incl. 2 valves, 2 O-rings, washer and lubricant	40 - 47 kg	0
4X147=1	Functional ring incl. 2 valves, 2 O-rings, washer and lubricant	48 - 55 kg	1
4X147=2	Functional ring incl. 2 valves, 2 O-rings, washer and lubricant	56 - 65 kg	2
4X147=3	Functional ring incl. 2 valves, 2 O-rings, washer and lubricant	66 - 75 kg	3
4X147=4	Functional ring incl. 2 valves, 2 O-rings, washer and lubricant	76 - 87 kg	4
4X147=5	Functional ring incl. 2 valves, 2 O-rings, washer and lubricant	88 - 100 kg	5
4X147=6	Functional ring incl. 2 valves, 2 O-rings, washer and lubricant	101 - 112 kg	6
4X147=7	Functional ring incl. 2 valves, 2 O-rings, washer and lubricant	113 - 125 kg	7

• For information on ordering additional single components, please see the pages 110, 112-114, 117, 120, 122.

4X148 Harmony P3 Service Set

Article number	4X148
Scope of Delivery	Washers (2x small, 2x large), 3 O-rings, lubricant

4R150 Harmony System HD

Recommended for heavy duty purposes, either heavy body weight or high level of activity. The rotation function can be blocked on the Harmony HD unit by OB Service if required. The 4R150 Harmony System HD must be used in conjunction with the 4R54 Socket Adapter with Pyramid Adapter.

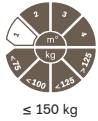

≤ 150 kg

Article number	4R150
Mobility grade	2 - 4
Material	Aluminum, Steel
Proximal connection	4-hole connection
Distal connection	Pyramid Receiver
System height	135 (incl. 4R54, not illustrated) mm
Weight	640 g
Max. body weight	150 kg

• Certification is required to fit the Harmony system.



4R152 Harmony E2

The quietest electronic pump on the market, the Harmony E2 offers high vacuum levels, resistance to dust and sweat, and submersibility in water. It's also the first removable vacuum solution: whether for charging, weight reduction, or switching between legs, the integrated valve keeps the vacuum secure.

The Harmony E2 provides ideal volume management, enhanced suspension and reduced forces in the socket. Add an Anatomic 3D Liner, a ProFlex Sleeve, and a Triton foot for comfort and confidence in one complete package.

- Max. vacuum is 22 inHG (750 mbar)



≤ 150 kg

Article number	Harmony E2	4-hole adapter plate
Material	-	Aluminium
System height	95 mm	22 mm
Weight	185 g	125 g
Max. body weight	-	150 kg
Operating temperature	-10 to +60 °C	-
Operating voltage	100 - 240 V	-
Power supply operating frequency	50 - 60 Hz	-
Charging temperature	0 - 45 °C	-



1
2
3
4
5
6
7
8
9
10
11
12
13
14



755E20=230 Harmony Vacuum Pump Set

The Harmony vacuum pump set is used for the fabrication of the plaster cast in vacuum technique.

Article number	755E20=230
-----------------------	-------------------

⦿ 230-volt Vacuum Casting Pump not available in the US – use 755E14=110V instead.

consisting of

683G1=10 Latex Casting Bags

For fabrication of the plaster cast in vacuum technique.

Article number	683G1=10
Size	Set with 1 each, small, medium and large (10)

755Z19=230 Vacuum Pump

Completely equipped with a fine regulating valve, a vacuum gauge and a silencer.

Article number	755Z19=230
Final vacuum	absolute 240 mbar
Delivery rate	11.5 l/min
Dimensions LxWxH	187/157/90 mm
Electrical connection in V/Hz/kW	230/50/0.065
Weight	2,5 kg
Colour (RAL)	9002 grey-white

⦿ Always use vacuum pump in conjunction with 755Z20=2 Filter.

625P1=1.0 Fuse Link, slow-blowing

as replacement fuse

Article number	625P1=1.0
-----------------------	------------------

616R2=10X2 PVC Suction Hose

transparent

Article number	616R2=10X2
Outside Ø	10 mm
Weight	0,06 kg/m

755Y16=1/4“X6 Threaded Hose Nozzle

Brass, for hose connection, 6mm, thread R1/4", spanner size 17

Article number	755Y16=1/4“X6
-----------------------	----------------------

683G1=1 Water Trap

Article number	683G1=1
-----------------------	----------------

683G1=5 Exhaust Tubing

Article number	683G1=5
-----------------------	----------------

755Z20=2 Filter

Article number	755Z20=2
Weight	0,015 kg

662F2 Bag

Article number	662F2
for	755E20=230

1

2

3

4

5

6

7

8

9

10

11

12

13

14

1



616S134 Spots

The spots are PU cushions used to compensate for variations in residual limb volume within the socket.

Article number	616S134=1	616S134=2	616S134=3	616S134=4	616S134=5
Ø	6 cm	9 cm	10 cm	12 cm	14 cm
Size	1	2	3	4	5
Packaging	1 Stück				

2

3

4



616S132 Sticky Spots

Same as 616S134 Spots, with additional adhesive coating for permanent adjustment of the residual limb volume.

Article number	616S132=1	616S132=2	616S132=3	616S132=4	616S132=5
Ø	6 cm	9 cm	10 cm	12 cm	14 cm
Size	1	2	3	4	5
Packaging	1 Stück				

5

6

7



451F20 Liner Fit Kit

Article number	451F20
Scope of Delivery	1 x 616S134=1 Spot 1 x 616S134=2 Spot 2 x 451F21=M Nylon Protective Sleeve 1 x 646C121 Harmony Fit Kit Video 1 x 451F18=2 Half Cotton Sock/medium 1 x 451F19=2 Half Cotton Sock/large 1 x 451F18=1 Cotton Sock/medium 1 x 451F19=1 Cotton Sock/large

8

9

10

11



4R128-1 Harmony Complete Installation Kit

Contains all components for the maintenance and service of the P2, DP and HD Harmony pumps.

Article number	4R128-1
Scope of Delivery	4Y310 Lock Rings, 10 pcs. 4Y350 Right-Angled Socket Attachment Block SL=4Y344 Straight Socket Attachment Block SL=40P074 Adjustment Block SL=2300-7167 Set Screw SL=2300-7174 Washers 4Y360=5 Hoses for Harmony Exhaust Valve 4Y348 Yellow Elastomer Rod 4Y347 Red Elastomer Rod 4Y309 Hose 4Y319=3 Protective Tube 4Y345 Exhaust Valves (on Harmony) 4Y346 Intake Valves (on Harmony)

12

13

14

453H1=1 Lubricating Cream

Increases the flow properties of PUR liners. Recommended use in conjunction with PUR liners (without textile).

Article number	453H1=1
-----------------------	----------------



1

2

3

2R119 Vacuum Connector

Easy-to-use vacuum connector for the connection between the socket and Harmony pump. The design is based on the PushValve and therefore makes it much easier to apply the prosthesis.

Article number	2R119
-----------------------	--------------



4

5

2R117 Socket Connector

Alternative, slim socket connector (connection between the socket and Harmony pump) with low structural height and rounded edges.

Article number	2R117
-----------------------	--------------

• For use with SL=P091 PU Adhesive.



6

7

8

9

10

11

12

13

14

1

2

3



453A2 Derma Protection Sealing Sleeve

The 453A2 Derma Protection Sealing Sleeve is a basic and durable sealing sleeve made from a tear-resistant copolymer gel and finished with a textile cover. The 453A2 Derma Protection Sealing Sleeve is mostly used as the primary suspension system or with a valve or Harmony System, and is suitable for amputees with a low to medium activity level.

Article number	453A2=1	453A2=2	453A2=3	453A2=4
Size	1	2	3	4
Length	~30 cm	~32 cm	~33 cm	
Knee centre circumference	24 – 32 cm	30 – 40 cm	34 – 44 cm	42 – 56 cm

4

5

6



Derma ProFlex is an anatomically shaped sealing sleeve made from a hard-wearing copolymer (TPE) with outer textile.

The anatomical shape results from a combination of 3 different features:

- Pre-flexion of 15° for easier knee flexion and reduced formation of wrinkles in the hollow of the knee
- Conical shape for comfortable pressure distribution in the area of the thigh and optimal adhesion to the prosthetic socket
- Pre-shaped patella section for reduced pressure on the patella during the entire range of movement

The interplay of these 3 factors provides for a previously unmatched level of functionality and wearer comfort for the user.

The Derma ProFlex knee sleeve can be used as the primary suspension system or with a valve or the Harmony system. It is suitable for users with a low to high activity level.

7

8

9

453A3 Derma ProFlex Sealing Sleeve

Article number	453A3=1	453A3=2	453A3=3
Size	1	2	3
Knee centre circumference	24 – 32 cm	30 – 40 cm	36 – 47 cm
Circumference 20 cm proximal to knee centre	34 – 46 cm	40 – 54 cm	48 – 66 cm

- Thigh length from MPT to proximal brim approx. 26 cm
- **ProFlex Sleeves also available in a (-7) Black color.**

10

11

12

13

14

453A4 Derma ProFlex Sealing Sleeve, short

Article number	453A4=1	453A4=2	453A4=3
Size	1	2	3
Knee centre circumference	24 – 32 cm	30 – 40 cm	36 – 47 cm
Circumference 20 cm proximal to knee centre	34 – 46 cm	40 – 54 cm	48 – 66 cm

- Thigh length from MPT to proximal brim approx. 26 cm
- **ProFlex Sleeves also available in a (-7) Black color.**

The Harmony sealing sleeve provides an excellent vacuum seal and is covered with a durable abrasion-resistant textile. It includes the gaiter sleeve protector to extend its life and retain its sealing properties. The Harmony sealing sleeve is mostly used with the Harmony System or a valve, and is suitable for users with a moderate to high activity level.

incl. 454A11 Gaiter



454A7 Harmony Sealing Sleeve, cylindrical

Article number	454A7=1	454A7=2	454A7=3	454A7=4	454A7=5
Size	1	2	3	4	5
Knee centre circumference	28 – 35.6 cm	30 – 37.5 cm	33 – 40.5 cm	35.5 – 43 cm	38 – 50.5 cm

454A8 Harmony Sealing Sleeve, conical

Article number	454A8=1	454A8=2	454A8=3	454A8=4	454A8=5	454A8=6	454A8=7
Size	1	2	3	4	5	6	7
Knee centre circumference	25.5 – 33 cm	30.5 – 37 cm	33 – 39 cm	37 – 44.5 cm	43 – 51 cm	48 – 58.5 cm	56 – 66 cm
Circumference 20 cm proximal to knee centre	35 – 43 cm	41 – 50 cm	44 – 54 cm	49 – 56 cm	53 – 66 cm	60 – 70 cm	66 – 75 cm

452A1 ProSeal Ring

Proximal sealing system for TF vacuum sockets.
Recommended in combination with the 6Y81 ProSeal SIL Liner.

Order example

Reference number = Proximal circumference

452A1 = 320

Reference number	452A1
Proximal circumference	320 mm, 340 mm, 360 mm, 380 mm, 400 mm, 420 mm, 440 mm, 460 mm, 480 mm, 500 mm, 520 mm, 540 mm, 560 mm, 580 mm, 600 mm, 640 mm
Scope of Delivery	Sealing ring, fixation ring, lamination dummy



647G597



1



21B37 Thigh Support Bandage

With Neoprene® adhesive strip

Order example

Reference number = side size

454A7 = L 1

2

3

646A230=GB

Reference number	21B37				
Side	Left (L), Right (R)				
Size	S (1)	M (2)	L (3)	XL (4)	XXL (5)
for hip circumference	60 – 74	66 – 80	76 – 90	86 – 100	96 – 110
Colour	beige				

4

5

6

7

8

9

10















11

12

13

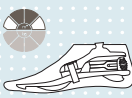
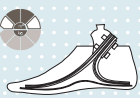
14

Neopren® is a registered trademark of DuPont.

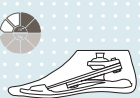
	TT	TF
Liner	 <p>6Y75 TransTibial SIL Liner with SkinGuard Technology</p>  <p>6Y70 TransTibial SIL Liner</p>  <p>6Y42 Basic SIL Liner</p>	 <p>6Y80/5 TransFemoral SIL Liner SkinGuard Technology</p>
Shuttle Locks	 <p>6A30=10</p>  <p>6A30=20</p>  <p>6A20=10</p>  <p>6A20=30</p>	 <p>6A20=20</p>  <p>4R160=1 4R160=2 KISS Lanyard System</p>
Adapter	 <p>5R1=6</p>  <p>5R2</p>  <p>4R54</p>  <p>4R77</p>	<p>Individual connection to knee joint or other modular components.</p>
Tube Adapter	 <p>2R57</p>  <p>4R82</p>  <p>4R72</p>	
Prosthetic Foot	 <p>1M10 Adjust</p>  <p>1D35 Dynamic Motion</p>  <p>1C30 Trias</p>  <p>1C40 C-Walk</p>  <p>1E56 Axtion</p>  <p>1C60 Triton</p>  <p>1C61 Triton Vertical Shock</p>  <p>1C63 Triton Low Profile</p>  <p>1C64 Triton Heavy Duty</p>	

1

2

3

4

5

6

7

8

9

10

11

12

13

14

1
2
3
4
5
6
7
8
9
10
11
12
13
14

Shuttle Lock

Application example

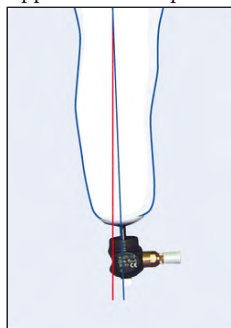

Always position the shuttle lock in the extension of the residual limb (blue line), never in the alignment reference line (red line).



647H218



6A20=10 Shuttle Lock with Pyramid Adapter

Serrated pin

- Coartier aluminium housing
- Easy to unlock ratchet unit, even under tensile load
- Continuously variable locking mechanism for secure support
- Adjustable: engages silently or audibly



Article number	6A20=10
Distal connection	Pyramid Adapter
System height	25 mm
Max. body weight	125 kg

- Enclosed: lamination anchor for integration into the laminate.



647H218



6A20=20 Shuttle lock with adjustment screw

Serrated pin

- Especially well suited for transtibial prostheses on long residual limbs or transfemoral prostheses
- Coartier aluminium housing
- Easy to unlock ratchet unit, even under tensile load
- Continuously variable locking mechanism for secure support
- Shorter pin
- Adjustable: engages silently or audibly



Article number	6A20=20
Distal connection	Adjustment Screw
System height	79 mm
Max. body weight	125 kg

- Enclosed: lamination anchor for integration into the laminate.

6A20=30 Shuttle Lock with Pyramid Adapter

Smooth pin

- Coartier aluminium housing
- Easy donning and doffing of the prosthesis
- Continuously variable locking mechanism for secure support



Article number	6A20=30
Distal connection	Pyramid Adapter
Max. body weight	100 kg

- Enclosed: lamination anchor for integration into the laminate.



647H328



1

2

3

4

6A30=10 Shuttle Lock

Serrated pin

- Coartier aluminium housing
- Easy to unlock ratchet unit, even under tensile load
- Continuously variable locking mechanism for secure support
- Adjustable: engages silently or audibly

Article number	6A30=10
-----------------------	----------------



647G415



5

6

7

8

6A30=20 Shuttle Lock

Waterproof and corrosion-resistant

- Serrated pin
- Lightweight plastic housing, therefore suitable for use in bathing prostheses
- Easy to unlock ratchet unit, even under tensile load
- Continuously variable locking mechanism for secure support
- Adjustable: engages silently or audibly

Article number	6A30=20
-----------------------	----------------



647H483



9

10

11

12

13

14

1



2

3

647G931



4

5

6

6A40 MagnoFlex Lock

Straightforward pin guide thanks to the unique combination of a flexible pin and a shuttle lock housing with integrated magnet

- The straightforward pin guide eliminates the arduous task of searching for the opening in the shuttle lock
- 1-step fabrication: quick and straightforward integration into the prosthesis
- The use of high-performance polyamide reduces the weight of the prosthesis while offering great durability
- With the supplied valve the fitting can be converted to a vacuum system quickly and easily
- The optional slider plate makes it easier to optimise the prosthesis settings

Area of application:

- Transfemoral and transtibial amputation
- Check sockets and definitive fittings



Article number	6A40
Distal connection	4-hole
System height	25 mm
Max. body weight	125 kg

• **MagnoFlex Lock available in Q3 2013.**

7

MagnoFlex Lock Accessories

8



9

6A42 Valve for shuttle lock

The valve is easy to glue into the opening of the shuttle lock housing. It serves to generate a vacuum in the socket. (A sealing sleeve is needed as the proximal seal.)

For use in check sockets and definitive fittings.

Article number	6A42
-----------------------	-------------

• The valve is included in the scope of delivery for the 6A40 MagnoFlex Lock.

10



11

12

13

14

6A41 Slider Plate for MagnoFlex Lock

Area of application

- Transfemoral and transtibial amputation
- Check sockets and definitive fittings



Article number	6A41
Displacement	Slide travel 12mm and 24mm
Max. body weight	125 kg

6A43 MagnoFlex Lock Socket Attachment Block

Area of application:

- Transfemoral and transtibial amputation
- Check sockets and definitive fittings



Article number	6A43
for	6A40
Max. body weight	125 kg

6Y13=F1 Flexible Pin for MagnoFlex Lock

Article number	6Y13=F1
Length	47.8 mm
for	6A40

1

2

3

4

5

6

7

8

9

10

11

12

13

14

1
2
3
4
5
6
7
8
9
10
11
12
13
14

Accessories

6Y13=1 Pin

Article number	6Y13=1
Length	49.5 mm
for	6A20=10, 6A30=10, 6A30=20

6Y13=2 Pin, short

Article number	6Y13=2
Length	31 mm
for	6A20=20

6Y13=3 Pin, smooth

Article number	6Y13=3
Length	48 mm
for	6A20=30

6Y13=L1 Pin, long

Article number	6Y13=L1
Length	68,7 mm
for	6A20=10, 6A30=10, 6A30=20

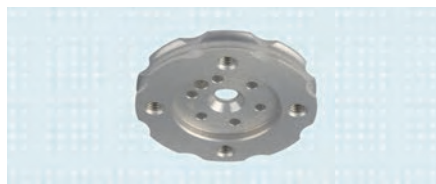

 647G179

5R2 Lamination Disc

Aluminium

The 5R2 Lamination Disc can be combined with various Ottobock socket adapters as well as the 6A30=20 Shuttle Lock system.



≤ 150 kg

Article number	5R2
Material	Aluminum
System height	9 mm
Weight	70 g
Max. body weight	150 kg

- The 4X86 Lamination Dummy has to be used for laminating. It is enclosed with the lamination disc.

6A94 Socket Mounting Plate

Article number	6A94=3
Colour	solid black

Single Components as Replacement Parts

Article number	6A20=10	6A20=20	6A20=30	6A30=10	6A30=20	6A40
4R111=N Lamination Anchor with Threaded Connector	■	■	■			
5X55 Dummy Set with Screw	■	■	■			
5X67 Push Button			■			
5X108 Dummy Set					■	
5X120 Shuttle Housing with Bushing					■	
5X125 Dummy Set				■		
5X440 Lamination Protection for Pin	■	■	■	■	■	
6A43 MagnoFlex Lock Socket Attachment Block						■
6A51=10 Shuttle Lock Housing with Pyramid Adapter	■					
6A51=20 Shuttle Lock Housing with adjustment screw		■				
6A51=30 Shuttle Lock Housing with Pyramid Adapter			■			
6A52 Ratchet Unit	■	■		■		
6A52=30 Release Button			■			
6A52=K Ratchet Unit					■	■
6A61 Push Button for 6A52	■	■		■	■	
6Y13=1 Pin	■			■	■	
6Y13=2 Pin, short	■	■		■	■	
6Y13=3 Pin, smooth			■			
6Y13=F1 Flexible Pin for MagnoFlex Lock						■
6Y13=F2 Pin, Flexible, Short for MagnoFlex Lock						■
6Y13=L1 Pin, long	■			■	■	
506G21=M4x10 Set Screw					■	

■ Can be ordered individually

1

2

3

4

5

6

7

8

9

10

11

12

13

14

1



KISS Lanyard Systems

The patented 4R160=1 and 4R160=2 KISS Lanyard systems are socket connection systems for transfemoral amputations.

Features & Benefits

- Proximal and distal connection between the socket and liner
- > Reduced pistoning and rotational movements
- Can be donned while sitting
- > Therefore particularly well suited for geriatric users and users with a low mobility grade

2

3



4



The Delrin KISS Kit requires a socket adapter to connect it to the modular system.

Application:

- Contracted residual limbs
- Carbon frame sockets in combination with ThermoLyn soft

5

6

646D336 647H529

Article number	4R160=1
-----------------------	----------------

7



The 4-hole endoskeletal KISS Kit features a direct connection to the modular system.

Application:

- Residual limb positions approximately equivalent to the alignment reference line
- Sockets that are completely laminated from ThermoLyn soft without using an inner socket

8

646D336 647H529

Article number	4R160=2
Max. body weight	150 kg (330 lbs)

9

10

11

12

13

14

Accessories

4R161 Lamination Set

The 4R161 Lamination Set is intended for endoskeletal fabrication in combination with the 4R160=2 4-Hole Endoskeletal KISS Kit.

Article number	4R161
-----------------------	--------------

4X225 Reinforcement Strips

The 4X225 Reinforcement Strips prevent the sock from fraying after punching the hole.

Article number	4X225
-----------------------	--------------

Spare Parts

4R163 KISS Delrin Base

Article number	4R163
-----------------------	--------------

4R164 KISS 4-Hole Base

Article number	4R164
-----------------------	--------------

4R165 KISS Distal Straps (2 pcs)

Article number	4R165
-----------------------	--------------

4R166 KISS Proximal Straps (2 pcs)

Article number	4R166
-----------------------	--------------

4R167 KISS Proximal Nut and Screw (set)

Article number	4R167
-----------------------	--------------

1

2

3

4

5

6

7

8

9

10

11

12

13

14

1

2

3

4

5

6

7

8

9

10

11

12

13

14

TT

TF

Sealing Sleeves



453A2
Derma Protection



453A3
Derma ProFlex



453A4
Derma ProFlex,
short



454A8
Harmony,
conical



452A1
ProSeal Ring

Liner



6Y400
Custom Liners



6Y523
Simplicity Tapered PUR Liner



6Y512
Anatomic 3D PUR Liner



6Y93
Balance TPE Liner



6Y81
ProSeal
SIL Liner



6Y540
AKquire PUR
Liner

Valve

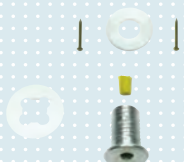

4R140

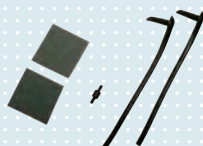

4R136=EL
V4 EasyLine Valve Kit



21Y14
PushValve



21Y21
ClickValve



21Y12

Adapter



5R1=6



4R54



4R77



5R2



4R116

Individual connection
to knee joint or other
modular components.

Tube Adapter



2R57



4R82



4R72

Prosthetic Foot

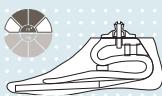

1D35
Dynamic Motion

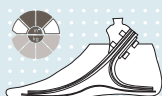

1C30 Trias

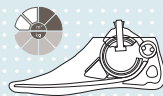

1C40 C-Walk

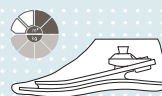

1E56 Axition

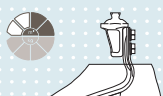

1C60
Triton



1C61
Triton Vertical Shock

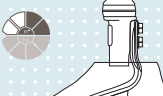

1C62
Triton Harmony

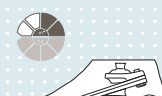

1C63
Triton Low Profile

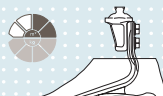

1C64
Triton Heavy Duty

Threadless Valves

21Y21 ClickValve

(with safety shackle in grey)

The ClickValve features a multi-option safety leash to avoid losing the upper valve part. Multi-option means:

- Complete use of the safety leash, OR
- Use of the upper grip section, OR
- No use of the safety leash

The significant height and outer diameter reduction as well as the unique design ensure good cosmetic processing in the socket.

Advantages for prosthetists and users:

- Conical shape for easy insertion in the lower valve part
- Multi-option safety leash avoids losing the upper valve part
- The "click" offers audible feedback for proper valve positioning
- Risk of haematoma is alleviated thanks to lateral air exhaust openings and a flush inside socket surface
- Straightforward and time-saving installation
- Good cosmetic aspect

Reference number	21Y21
Area of application	Transfemoral amputation



 647G678



21Y14 PushValve

The PushValve is opened and closed by pressing together two wings. Due to the higher dimension, it is especially well suited for users with limited finger mobility and for arm prosthesis wearers.

Reference number	21Y14
Area of application	Transfemoral amputation



 647H530



21Y15 MagValve

The MagValve has a low structural height and is closed with magnetic force.

Reference number	21Y15
Area of application	Upper and Lower Limbs



 647H530



1

2

3

4

5

6

7

8

9

10

11

12

13

14

1

Accessories/Spare Parts

21Y230=0 ClickValve Safety Leash, skin colour

Article number	21Y230=0
----------------	----------

2

21Y230=1 ClickValve Safety Leash, grey

Article number	21Y230=1
----------------	----------

3

21Y21=B ClickValve Base

Article number	21Y21=B
----------------	---------

4

627F13=24.5X3 O-Ring for ClickValve, black

Article number	627F13=24.5X3
----------------	---------------

5

627F13=19x2 O-Ring for ClickValve Upper Valve Part, blue

Article number	627F13=19x2
----------------	-------------

6

21Y14=S PushValve Upper Section

Article number	21Y14=S
----------------	---------

7

21Y15=S MagValve Upper Section

Article number	21Y15=S
----------------	---------

8

9

10

11

12

13

14

Threaded Valve Set

21Y12 Threaded Valve Set

Article number	21Y12
Area of application	Transfemoral amputation



Service part

21Y222 Two hole pin wrench for 21Y14, 21Y15, 21Y12 and 21Y21

already included in 21Y12, 21Y14, 21Y15 and 21Y21

Article number	21Y222
-----------------------	---------------



Flat Valve Sets

21Y96 Valve Set

Article number	21Y96
Outside Ø	40 mm
for	Interim socket
Consisting of	Flat rubber valve, insert ring, O-ring, fixing ring, plastic screw disc
for hole Ø	24 mm
Substance of content	contains nickel



21Y97 Valve Set

Article number	21Y97
Outside Ø	40 mm
for	flexible residual limb socket
Consisting of	Flat rubber valve, insert ring, valve seat with tube, lamination ring, sealing ring, vacuum forming pattern, casting pattern, screw, flat head screw and plastic screw disc
for hole Ø	24 mm
Substance of content	contains nickel



1



21Y105 Valve Set

Article number	21Y105
Outside Ø	40 mm
for	flexible residual limb socket
Consisting of	Flat rubber valve, insert ring, lamination ring, sealing ring, vacuum forming pattern, casting pattern, screw, flat head screw and plastic screw disc
for hole Ø	24 mm
Substance of content	contains nickel



3

4



21Y81 Screw Valve

with automatic air outlet, plastic

Article number	21Y81
Outside Ø	40 mm
for hole Ø	24 mm



5

6

Valves

7



21Y140 Flat Silicone Valve

with thumb flap, without seat ring

Article number	21Y140
Seat ring outside Ø	40 mm
for hole Ø	24 mm
Substance of content	contains nickel



8

9



21Y123=40 21Y123 Flat Rubber Valve

Article number	21Y123=40
for	for contact socket, with thumb flap, without seat ring
Seat ring outside Ø	40 mm
for hole Ø	24 mm
Substance of content	contains nickel



10

11

12



21Y94 Flat Rubber Valve

Article number	21Y94
for	for contact socket, with 50 mm socket attachment, thumb flap and seat ring
Seat ring outside Ø	40 mm
for hole Ø	24 mm
Substance of content	contains nickel



13

14

21Y95 Flat Rubber Valve

with automatic air outlet, with seat ring

Article number	21Y95
Seat ring outside Ø	40 mm
for hole Ø	24 mm
Substance of content	contains nickel



21Y45 Flat Rubber Valve, small

without seat ring

Article number	21Y45
Seat ring outside Ø	32 mm
for hole Ø	20 mm
Substance of content	contains nickel

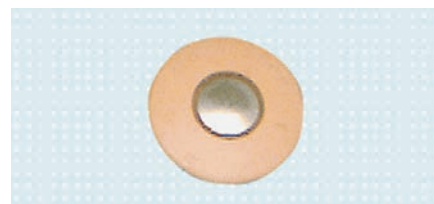

21Y41 Seat Ring

Article number	21Y41=32	21Y41=40
Outside Ø	32 mm	40 mm
for	flat rubber valves	
for hole Ø	20 mm	24 mm



21Y77 Connecting tube with seat ring

Article number	21Y77
Outside Ø	28 mm
for	For valves with 40 mm outside Ø
Tube inside Ø	24 mm



99B13 PVC Connection Tube

as a connection channel between the inner and outer socket

Article number	99B13=16	99B13=16-7	99B13=21	99B13=21-7
Ø	16 mm		21 mm	
Colour	skin colour	black	skin colour	black



1

2

3

4

5

6

7

8

9

10

11

12

13

14

- 1
- 2
- 3
- 4
- 5
- 6
- 7
- 8
- 9
- 10
- 11
- 12
- 13
- 14

Transtibial Valve Socket System

4R140 One-way Valve

The 4R140 One-way Valve suitable for the fabrication of vacuum socket systems. It is integrated directly in the socket. The 4R140 Discharge Valve is only for use with transtibial prosthetic fittings.

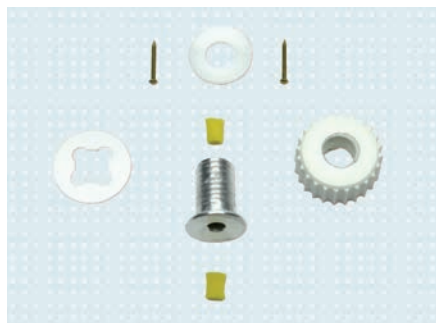

 647G148



Article number	4R140
-----------------------	--------------

4R136=EL V4 EasyLine Valve Kit

The V4 EasyLine Valve Kit is suitable for fabricating vacuum socket systems and represents an advancement of the proven 4R136 V4 Valve Kit. Installation is simplified thanks to the reduced number of components. Consisting of a socket connector and plastic valve, it helps create a secure and functional discharge valve solution.

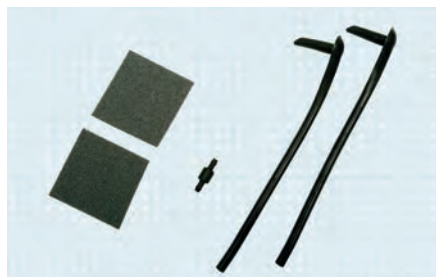

 647G529



Article number	4R136=EL
-----------------------	-----------------

4R138=EL V5 EasyLine Valve Kit

The V5 EasyLine Valve Kit is suitable for fabricating vacuum socket systems and represents an advancement of the proven 4R138=5 V5 Valve Kit. Installation is simplified thanks to the reduced number of components. Consisting of a socket connector and metal valve, it helps create a secure and functional discharge valve solution.



 647G529



Article number	4R138=EL
-----------------------	-----------------

 **4R138=EL not available in the US - use 4R136=EL instead.**

Spare Parts

4R142 V4 Valve, straight

Article number	4R142
Material	Aluminum
Scope of Delivery	5 pcs

4R138 V5 Valve, straight

Reference number	4R138
Scope of Delivery	1 pc

ⓘ **4R138 V5 not available in the US - use 4R142 instead.**

1
2
3
4
5
6
7
8
9
10
11
12
13
14

Derma Seal Residual Limb Socks

Wearing a prosthesis or orthosis often applies intense loads to areas of the skin that nature did not intend to be stressed. This can lead to pain from excessive pressure or friction, to perspiration build-up and similar problems. The Derma range of products can help you successfully prevent or reduce excessive strain on the skin.

The Derma Seal residual limb socks are the ideal solution for transtibial amputees. The socks are coated with a special polymer gel. The viscous nature of the gel reduces chafing, pressure and strain on the skin and thus offers increased comfort in the prosthetic socket. The gel coating represents another advantage: the polymer gel contains a medical-grade mineral oil which is especially skin-friendly and keeps the skin supple.

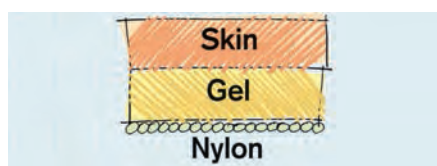

453D7 Derma Seal

This sock is made of nylon stretch fabric and is coated with a soft polymer gel.

647H106

Article number	453D7=1	453D7=2	453D7=3	453D7=4	453D7=5	453D7=6	453D7=7	453D7=8
Sock length	30 cm	40 cm	40 cm	45 cm	45 cm	50 cm	50 cm	50 cm
Gel length	20 cm	25 cm	25 cm	33 cm	25 cm	33 cm	33 cm	33 cm
Distal circumference	16-22 cm	18-26 cm	20-31 cm	20-31 cm	23-35 cm	23-35 cm	27-40 cm	30-48 cm
Proximal circumference	16-25 cm	18-30 cm	20-35 cm	20-35 cm	23-40 cm	23-40 cm	27-45 cm	30-53 cm

* Possible deviation: ± 10 %

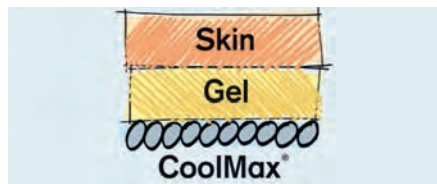

453D4 Derma Seal Forte

The CoolMax® fabric offers increased durability and wearer comfort. The soft polymer gel is applied to the inside of the textile material.

647H106

Article number	453D4=1	453D4=2	453D4=3	453D4=10	453D4=20
Sock length	30 cm	30	40 cm	65 cm	75 cm
Gel length	25 cm	25 cm	30 cm	25 cm	30 cm
Distal circumference	15 – 22 cm	20 – 26 cm	20 – 26 cm	15 – 22 cm	20 – 26 cm
Proximal circumference	20 – 32 cm	28 – 42 cm	28 – 45 cm	20 – 32 cm	28 – 42 cm

* Possible deviation: ± 10 %

453D5 Derma Seal Double Forte

This sock consists of two CoolMax® fabric layers. The soft polymer gel is applied between these two textile layers. This makes it even more durable.

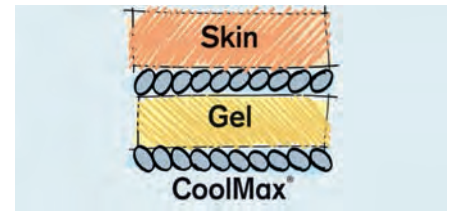

 647H106

Article number	453D5=1	453D5=2	453D5=3	453D5=10	453D5=20
Sock length	30 cm	30 cm	40 cm	65 cm	75 cm
Gel length	25 cm	25 cm	30 cm	25 cm	30 cm
Distal circumference	15 – 20 cm	20 – 24 cm	20 – 24 cm	15 – 20 cm	20 – 24 cm
Proximal circumference	20 – 28 cm	28 – 40 cm	28 – 43 cm	20 – 28 cm	28 – 40 cm

* Possible deviation: ± 10 %

453D2 Derma Seal Trans Ped

This very stretchable sock is for Lisfranc/Chopart partial foot amputees. The Trans Ped is seamlessly knitted and made of 95% polyester and 5% Lycra® Spandex. The distal area inside the sock features a soft polymer gel layer, which protects this area from chafing, pressure and loading forces.



 647H107

Article number	453D2=N	453D2=XL
Size	standard	extra long
Sock length	22 cm	50 cm

Lycra® is a registered trademark of DuPont.

Residual Limb Socks

1

2

3

4

5

6

7

8

9

10

11

12

13

14



451F2 Terry Cloth Residual Limb Sock

white, soft terry cloth,
Transtibial fitting

Article number	451F2=20	451F2=25	451F2=30	451F2=35	451F2=40	451F2=45	451F2=50	451F2=60	451F2=80
Material	85% cotton, 15% polyamide								
Length	20 cm	25 cm	30 cm	35 cm	40 cm	45 cm	50 cm	60 cm	80 cm
Colour brim	green	navy	yellow	royal blue	brown	black	orange	red	white



451F3 Cotton Residual Limb Sock

white, fine and thin,
Transtibial fitting

Article number	451F3=20	451F3=25	451F3=30	451F3=35	451F3=40	451F3=45	451F3=50	451F3=60
Material	80% cotton, 17% polyamide, 3% Lycra®							
Length	20 cm	25 cm	30 cm	35 cm	40 cm	45 cm	50 cm	60 cm
Colour brim	green	navy	yellow	royal blue	brown	black	orange	red



451F4 Nylon Residual Limb Sock for liners with connection

white, with vulcanised ring,
transtibial and transfemoral fittings

Article number	451F4=11-30	451F4=11-40	451F4=20-30	451F4=20-40
Material	90% polyamide, 10% Lycra®			
Length	30 cm	40 cm	30 cm	40 cm
Amputation level	transtibial (11)		transfemoral (20)	

451F6 Terry Cloth Residual Limb Sock for liners with distal connection

white, with vulcanised ring,
transtibial and transfemoral fittings

Article number	451F6=11-30	451F6=11-40	451F6=20-30	451F6=20-40
Material	85% cotton, 15% Lycra®			
Length	30 cm	40 cm	30 cm	40 cm
Amputation level	transtibial (11)		transfemoral (20)	



451F21 Nylon Protective Sleeve

transtibial fittings,
proximal double seam

Article number	451F21=S	451F21=M	451F21=L
Size	S	M	L
Length	25,5 cm	33 cm	40,5
Proximal circumference	20 cm	22 cm	23 cm



451U9 Nylon Protective Sleeve

Transtibial fitting

Article number	451U9=25	451U9=35	451U9=45	451U9=60	451U9=65
Length	25 cm	35 cm	45 cm	60 cm	65 cm
Width of coarse seam	17 cm				
for circumferences below the knee	up to 35 cm				
Shape	D				



451U1 Woolen Residual Limb Sock

Transtibial fitting

Article number	451U1=35	451U1=45	451U1=60
Material	70% new wool, 30% rayon		
Length	35 cm	45 cm	60 cm
Colour brim	royal blue	black	pink



1

2

3

4

5

6

7

8

9

10

11

12

13

14

1
2
3
4
5
6
7
8
9
10
11
12
13
14

Residual Limb Compression Socks

Residual limb compression socks offer significant assistance during postoperative residual limb care. They ensure constant pressure on the residual limb, which decreases from distal to proximal, while at the same time offering a high level of wearer comfort for the user.

Residual limb compression socks can be used by transtibial and transfemoral amputees. Application is quick and easy.

Residual limb compression socks should only be used when prescribed by a physician and only issued by trained, authorised personnel. In order to extend the lifespan of the socks, we recommend that you wear rubber gloves when putting the socks on and taking them off. This ensures that the socks are not damaged by fingernails or jewellery.

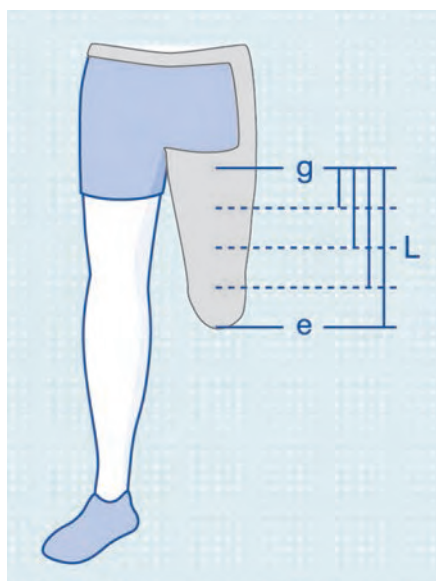

Compression Residual Limb Sock

Transfemoral fitting with hip attachment

Order example

Reference number	=	Size	-	Length
451F12	=	XS	-	20

Reference number	451F12					
Size	XS	S	M	L	XL	XXL
compression class	KKL1					
Lengths (L) g-e	20 cm, 25 cm, 30 cm, 35 cm					
Circumference e	29 – 31 cm	31 – 34 cm	34 – 37 cm	37 – 40 cm	40 – 43 cm	43 – 46 cm
Circumference g	41 – 44 cm	44 – 48 cm	48 – 52 cm	52 – 56 cm	56 – 60 cm	60 – 64 cm

Order example

Reference number	=	Size	-	Length
451F11	=	XS	-	20

Reference number	451F11					
Size	XS	S	M	L	XL	XXL
compression class	KKL2					
Lengths (L) g-e	20 cm, 25 cm, 30 cm, 35 cm					
Circumference e	29 – 31 cm	31 – 34 cm	34 – 37 cm	37 – 40 cm	40 – 43 cm	43 – 46 cm
Circumference g	41 – 44 cm	44 – 48 cm	48 – 52 cm	52 – 56 cm	56 – 60 cm	60 – 64 cm

Not available in the US

Compression Residual Limb Sock

Transtibial fitting with silicone adhesive strip

Order example

Reference number	=	Size	-	Length	-	N
451F13	=	XS	-	30	-	N

Reference number	451F13					
Size	XS	S	M	L	XL	XXL
compression class	KKL1					
Lengths (L) g-e	30 cm, 38 cm, 46 cm					
Circumference f	39 – 41 cm	41 – 44 cm	44 – 47 cm	47 – 50 cm	50 – 53 cm	60 – 64 cm
Circumference e	29 – 31 cm	31 – 34 cm	34 – 37 cm	37 – 40 cm	40 – 43 cm	43 – 46 cm
Circumference c	27 – 29 cm	29 – 32 cm	32 – 35 cm	35 – 38 cm	38 – 41 cm	41 – 44 cm

Transtibial fitting

Order example

Reference number	=	Size	-	Length	-	N
451F10	=	XS	-	30	-	N

Reference number	451F10					
Size	XS	S	M	L	XL	XXL
compression class	KKL2					
Lengths (L) g-e	30 cm, 38 cm, 46 cm					
Circumference f	39 – 41 cm	41 – 44 cm	44 – 47 cm	47 – 50 cm	50 – 53 cm	60 – 64 cm
Circumference e	29 – 31 cm	31 – 34 cm	34 – 37 cm	37 – 40 cm	40 – 43 cm	43 – 46 cm
Circumference c	27 – 29 cm	29 – 32 cm	32 – 35 cm	35 – 38 cm	38 – 41 cm	41 – 44 cm

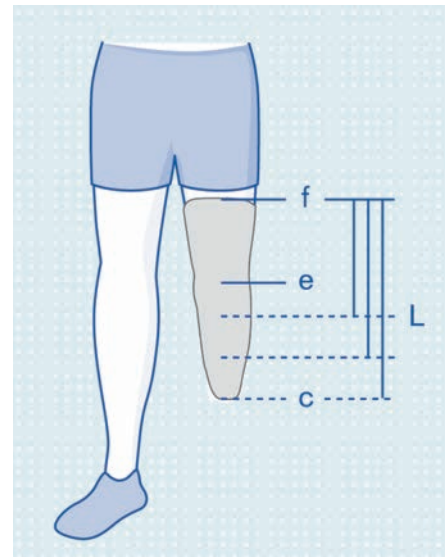

Not available in the US

- 1
- 2
- 3
- 4
- 5
- 6
- 7
- 8
- 9
- 10
- 11
- 12
- 13
- 14

1
2
3
4
5
6
7
8
9
10
11
12
13
14

Air Contact System by Pohlig

The Air Contact System (ACS) was designed in cooperation with Kurt Pohlig for flexible transfemoral sockets. The ACS is recommended for accommodating variations in the volume of the residual limb or a patient's varying needs for increased socket adhesion. Air chambers come in a variety of sizes and are positioned between the flexible residual limb socket and the outer socket. The amputee can inflate or deflate the chambers to compensate for volume changes as needed. The distal air chamber allows for adjustment of the load on the end of the residual limb. The ACS by Pohlig is recommended for all age groups and for those engaged in sports.

 646T2=3.7D (Technician)
 646D33 (Patient)



5D1 Three-Way Valve

With mounted ball pump, complete with polyurethane hoses, mounting screw with setting nut and cover cap

Article number	5D1
-----------------------	------------



5S1 Lateral Air Chamber

with pad dummy and solid round hose spacer

Article number	5S1=140X60	5S1=170X60	5S1=80X60	5S1=95X80
for	lateral side	lateral side	lateral/medial side	medial side

5S2 Distal Air Chamber

with metal and plastic coupling, PE cap, 5F1 Terry Cloth Cover, vacuum forming dummy, solid round hose spacer and plug

Article number	5S2
-----------------------	------------

Not available in the US

Accessories

634A61 ACS Cold Weld Material

Bottle with 35 g net contents

Article number	634A61
-----------------------	---------------



616R11=3.2X1.6X500 PU Hose

Article number	616R11=3.2X1.6X500
-----------------------	---------------------------



5F1 Terry Cloth Covers

Package of 10

Article number	5F1
-----------------------	------------



6T2 Pedilin Cone for Soft Socket

Pedilin has proven itself for soft inner sockets for years. The material is skin-friendly, retains its shape and is hygienic. The prefabricated cones have a precise, stable bonded edge. Ready for thermoplastic shaping, our Pedilin cones save you sanding and gluing time.

Article number	6T2=1	6T2=2	6T2=3
Distal circumference	200 mm	270 mm	300 mm
Proximal circumference	390 mm	425 mm	485 mm
Thickness	5 mm	5 mm	5 mm



5T8 Procomfort Inner Socket

Older patients especially prefer to put on their prosthesis while sitting and without assistance. Ottobock offers the Procomfort inner socket as a practical solution. The individually shaped inner socket of polyurethane replaces the stockinette normally used for donning a transfemoral prosthesis. The Procomfort inner socket is rolled directly onto the residual limb. An especially formulated gel assists the amputee in slipping into the prosthesis while also improving the adhesion between the Procomfort socket and prosthetic socket.

Article number	5T8=1	5T8=2
Distal circumference	36 – 42 cm	28 – 36 cm
Proximal circumference	49 – 71 cm	43 – 63 cm



646D34

647H118

1



633S2 Procomfort Gel

acts as a lubricant to aid in donning the prosthetic glove over the inner hand.

2

3

4

5

6

7

8

9

10

11

12

13

14

Article number

633S2

Net contents

250 ml

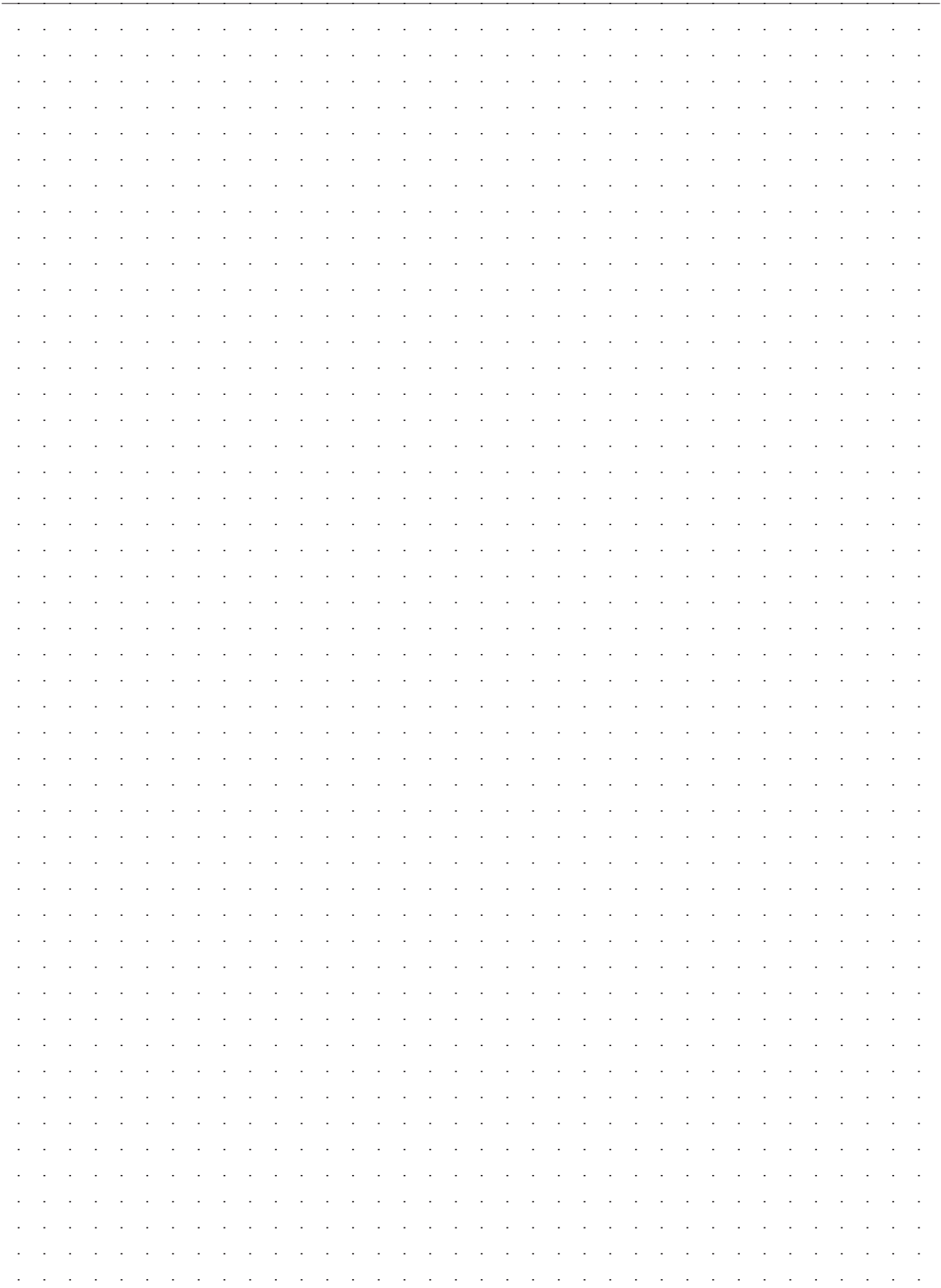

1
2
3
4
5
6
7
8
9
10
11
12
13
14

1

2

3

4

5

6

7

8

9

10

11

12

13

14



Cosmetic Covers

In addition to the functional reconstruction of the lost limb, most amputees also desire an inconspicuous or visually enhanced appearance. The outer design of the prosthesis as a cosmetic functional fitting for all amputation heights of the lower limb is therefore of particular significance. Ottobock therefore offers foam covers, socks, and aesthetic improvement techniques for exterior design.

All foam covers are equipped with a bore hole. The bore holes have different diameters adapted to the modular components. For transtibial prostheses, select between foam covers with 30 mm or 34 mm bore hole diameters according to the corresponding diameter of the Ottobock tube adapter and tube clamp adapter.

Transfemoral foam covers are predrilled, adapted to the contours of the Ottobock knee joints. Use the combination overview on page 280 to identify at a glance which cover is suitable for which knee joint.

The 3S106 and 3S124 models support a time-saving cosmetic design. Conical openings in the socket area make it easier to fit the socket. Both cosmetic foam covers are also anatomically pre-shaped.

With Ottobock SuperSkin coating technology, you can colour the finished, moulded PUR foam covers and protect them against splashed water. SuperSkin provides cosmetically attractive results. Similar effects are also possible with Ottobock SoftTouch cosmetic stockings on transtibial prostheses.

Nylon cosmetic stockings of various sizes and colours with anti-slip rubber cuff form the exterior cosmetic cover.

Ottobock Service Fabrication offers a special service. Here cosmetic foam covers are fabricated quickly according to the individual measurements of the amputee. Through Ottobock Customer Service, you can have individual coatings applied to foam covers using aesthetic refinement techniques.

1

2

3

4

5

6

7

8

9

10

11

12

13

14

Overview of Combinations

	3R6	3S106	3R24	3S124	3S107	3S26	3S27*	6R6	6R8	6R18
3C86-1 C-Leg compact						■				
3C88-1 C-Leg						■				
3C96-1 C-Leg compact						■	■			
3C98-1 C-Leg						■	■			
3R15	■	■								
3R17			■	■						
3R20			■	■			■			
3R21	▣							■		
3R23	▣							■		
3R30	▣							■		
3R32	▣							■		
3R33			■	■						
3R36			■	■			■			
3R40			■	■						
3R46	▣							■		
3R49	■	■								
3R55	■	■								
3R60					■					
3R60=KD					▣			■		
3R60=ST					■					
3R60=HD					■		■			
3R60-PRO					■					
3R60-PRO=KD					▣			■		
3R60-PRO=ST					■					
3R60-PRO=HD					■		■			
3R72					■					
3R78	■	■								
3R80					■					
3R90					■					
3R92					■					
3R93		■			■					
3R95			■	■						
3R95=1			■	■						
3R106					■					
3R106=KD					▣			■		
3R106=ST					■					
3R106=HD					■		■			
Transstibial								■	■	■

▣ The respective knee joints are intended for knee disarticulation fittings, which are usually cosmetically finished with the 6R6 Lower Leg Prosthetic Cover. If required, the exterior finish can also be realised with the 3R6 or 3S107 Thigh Cosmetic Cover.

* Suitable for all Ottobock hip joints

6R8 Foam Cover

The 6R8 Cover for modular transtibial prostheses has a 30 or 34 mm diameter bore hole and is not pre-shaped.

It can be used on the left or right side.

Article number	6R8=30	6R8=34
for tube diameter	30 cm	34 cm
Material	PE foam	PE foam
Length	approx. 48 cm	approx. 48 cm
Colour	beige	beige

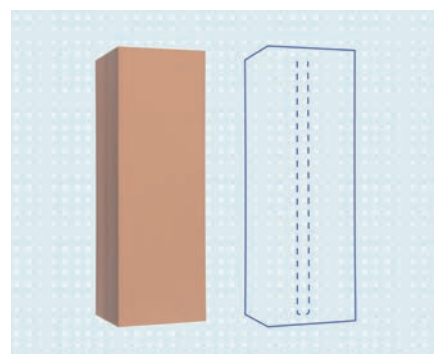

6R18 Foam Cover

The 6R18 Cover for modular transtibial prostheses has a 30 or 34 mm diameter bore hole and is not pre-shaped.

It can be used on the left or right side.

Article number	6R18=30	6R18=34
for tube diameter	30 cm	34 cm
Material	PE foam	PE foam
Length	approx. 48 cm	approx. 48 cm
Colour	beige	beige



6R6 Foam Cover

The 6R6 Cover for modular transtibial and knee disarticulation prostheses has a bore hole with a diameter suitable for the cosmetic shell of a Ø 30 mm system or a Ø 34 mm system, and is not pre-shaped. It can be used on either the left or right side.

Article number	6R6
for tube diameter	30 and 34 cm
Material	PUR flexible foam
Length	approx. 55 cm
for knee joints	3R21 3R23 3R30 3R32 3R46 3R60=KD 3R60-PRO=KD 3R106=KD
Colour	beige



- The material is flame retardant according to DIN 75200 and meets MVSS 302 ≤ 100 mm.



Custom Foam Covers from Ottobock Service Fabrication

If you would like to reduce the milling volume or need special sizes, you can order custom-made foam covers according to your customer's measurements through Ottobock Service Fabrication.

1

2

3

4

5

6

7

8

9

10

11

12

13

14

1

2

3

4

5

6

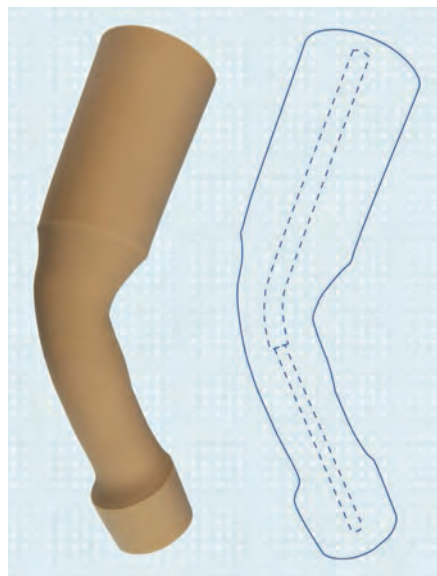

3R6 Foam Cover

The 3R6 Cover for modular transfemoral prostheses has a stepped centre hole and is pre-shaped.

Order example

Reference number	=	Side	Calf circumference
3R6	=	L	36

Reference number	3R6
Material	PUR flexible foam
Calf circumference	36 cm, 40 cm, 44 cm
Knee flexion	30 °
Side	Left (L), Right (R)
Length	approx. 94 cm
for knee joints	3R15 3R49 3R55 3R21 3R23 3R30 3R32 3R46 3R78
Colour	beige

◦ The material is flame retardant according to DIN 75200 and meets MVSS 302 ≤ 100 mm.

7

8

9

10

11

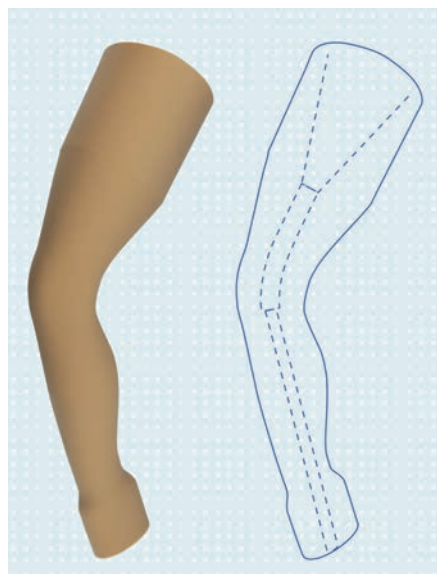

3S106 Foam Cover

The 3S106 Cover for modular transfemoral prostheses has a stepped centre hole and is cosmetically pre-shaped in the area of the knee and ankle. The cover is also conically predrilled for inserting the prosthetic socket.

Order example

Reference number	=	Side	Calf circumference
3S106	=	L	44

Reference number	3S106
Material	PUR flexible foam
Calf circumference	36 cm, 40 cm, 44 cm
Knee flexion	35 °
Side	Left (L), Right (R)
Length	approx. 94 cm
for knee joints	3R15 3R49 3R55 3R78 3R93
Colour	beige

◦ The material is flame retardant according to DIN 75200 and meets MVSS 302 ≤ 100 mm.

12

13

14



3R24 Foam Cover

The 3R24 Cover for modular transfemoral prostheses has a stepped centre hole and is pre-shaped. In addition to the knee joints listed below, it is also designed for prostheses with a knee joint combined with the 99B17 Knee Protector with Extension Assist Belt.

Order example

Reference number	=	Side	Calf circumference
3R24	=	R	40

Reference number	3R24
Material	PUR flexible foam
Calf circumference	36 cm, 40 cm, 44 cm
Knee flexion	30 °
Side	Left (L), Right (R)
Length	approx. 94 cm
for knee joints	3R17 3R20 3R22 3R33 3R34 3R36 3R40 3R95 3R95=1
Colour	beige

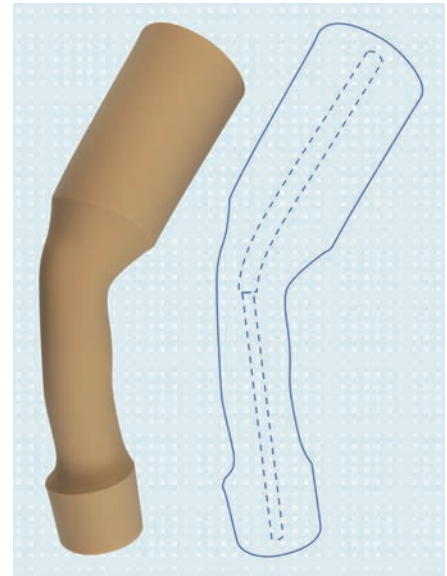

- The material is flame retardant according to DIN 75200 and meets MVSS 302 ≤ 100 mm.



Custom Foam Covers from Ottobock Service Fabrication

If you would like to reduce the milling volume or need special sizes, you can order custom-made foam covers according to your customer's measurements through Ottobock Service Fabrication.

1

2

3

4

5

6

7

8

9

10

11

12

13

14

1

2

3

4

5

6

7

8

9

10

11

12

13

14

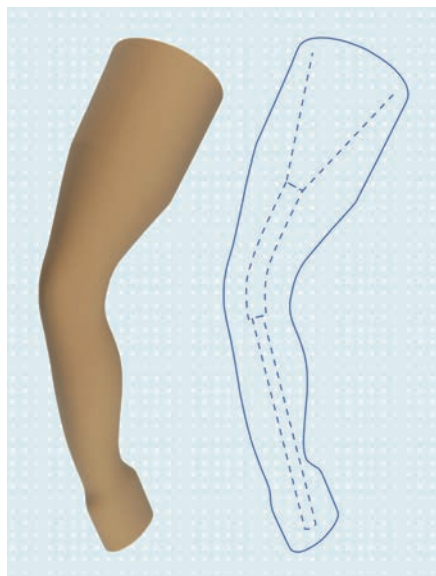

3S124 Foam Cover

The 3S124 Cover for modular transfemoral prostheses has a stepped centre hole and is cosmetically pre-shaped in the area of the ankle and knee. The cover is also conically predrilled for inserting the prosthetic socket. In addition to the knee joints listed below, it is also designed for prostheses with a knee joint combined with the 99B17 Knee Protector with Extension Assist Belt.

Order example

Reference number	=	Side	Calf circumference
3S124	=	L	40

Reference number	3S124
Material	PUR flexible foam
Calf circumference	36 cm, 40 cm, 44 cm
Knee flexion	35 °
Side	Left (L), Right (R)
Length	approx. 94 cm
for knee joints	3R17 3R20 3R22 3R33 3R34 3R36 3R40 3R95 3R95=1
Colour	beige

- The material is flame retardant according to DIN 75200 and meets MVSS 302 ≤ 100 mm.

3S107 Foam Cover

The 3S107 Cover for modular transfemoral prostheses has a stepped centre hole and is pre-shaped.

Order example

Reference number	=	Side	Calf circumference
3S107	=	R	40

Reference number	3S107
Material	PUR flexible foam
Calf circumference	40 cm, 44 cm
Knee flexion	35 °
Side	Left (L), Right (R)
Length	approx. 94 cm
for knee joints	3R106 3R106=KD 3R106=ST 3R106=HD* 3R60 3R60=ST 3R60=HD* 3R60=KD 3R60-PRO 3R60-PRO=KD 3R60-PRO=ST 3R60-PRO=HD* 3R72 3R80 3R90 3R92 3R93
Colour	beige

- The material is flame retardant according to DIN 75200 and meets MVSS 302 ≤ 100 mm.

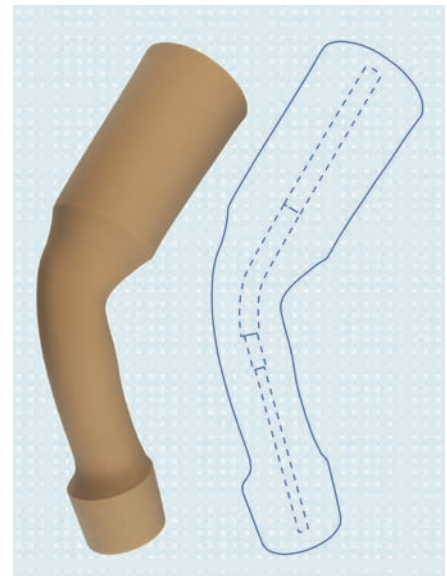

1

2

3

4

5

6

7

8

3S26 Foam Cover

The 3S26 Cover for modular transfemoral prostheses has a stepped centre hole and is pre-shaped.

Order example

Reference number	=	Side	Calf circumference
3S26	=	R	44

Reference number	3S26
Material	PUR flexible foam
Calf circumference	44 cm
Knee flexion	30 °
Side	Left (L), Right (R)
Length	approx. 94 cm
for knee joints	3C88-2 3C98-2 3C86-1 3C96-1
Colour	beige

- The material is flame retardant according to DIN 75200 and meets MVSS 302 ≤ 100 mm.

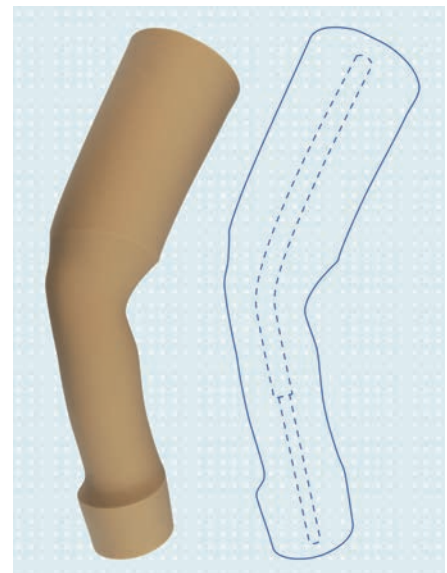

9

10

11

12

13

14

1

2

3

4

5

6

7

8

9

10

11

12

13

14

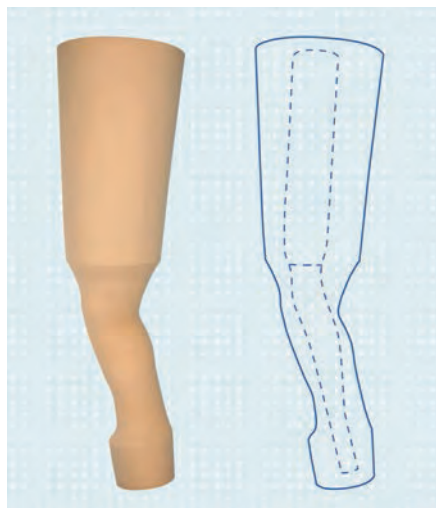

3S27 Foam cover for hip disarticulation fittings

The 3S27 Cover for modular pelvic prostheses has a stepped centre hole and is pre-shaped.

Order example

Reference number	=	Side	Calf circumference
3S27	=	R	44

Reference number	3S27
Material	PUR flexible foam
Calf circumference	44 cm
Knee flexion	20 °
Side	Left (L), Right (R)
Length	approx. 110 cm
for	7E5 Hip Joint with 3R20, 3R36 Knee Joint 7E4 Hip Joint with 3R20, 3R36, 3R60=HD, 3R60-PRO=HD Knee Joint 7E7 Hip Joint with 3R36, 3R106=HD, 3R60=HD, 3R60-PRO=HD Knee Joint 3C96-1 C-Leg compact, 3C98-1 C-Leg 7E10 Helix ^{3D} Hip Joint with 3C98-1 C-Leg Knee Joint
Colour	beige

• The material is flame retardant according to DIN 75200 and meets MVSS 302 ≤ 100 mm.



Custom Foam Covers from Ottobock Service Fabrication

If you would like to reduce the milling volume or need special sizes, you can order custom-made foam covers according to your customer's measurements through Ottobock Service Fabrication.

99B116 SoftTouch Stockings for Transtibial Prostheses (2 pcs.)

The Ottobock SoftTouch socks have a special surface coating.

They are pulled over the cosmetic foam cover. This makes the modular lower limb prostheses:

- splash-proof
- more resistant to dirt
- visually more attractive

SoftTouch stockings are extremely stretchable. They are available for transtibial prostheses in small, medium and large sizes, in 10 colours each, and especially well suited for combining with the 6R8 or 6R18 PE Foam Cover.

Order example

Reference number = Size - Colour
99B116 = 2 - 12



 647H267

Reference number	99B116		
Size	2	4	6
Ankle circumference	19 – 21 cm	22 – 25 cm	26 – 29 cm
Calf circumference	30 – 33 cm	34 – 39 cm	40 – 45 cm
Foot length	≥ 21 cm	≥ 23 cm	≥ 25 cm
Colour	Colour 0, Colour 2 (2), Colour 4 (4), Colour 6 (6), Colour 8 (8), Colour 10 (10), Colour 12 (12), Colour 14 (14), Colour 16 (16), Colour 18 (18)		

• Please use the 646M22 Colour Sample Set for colour selection.

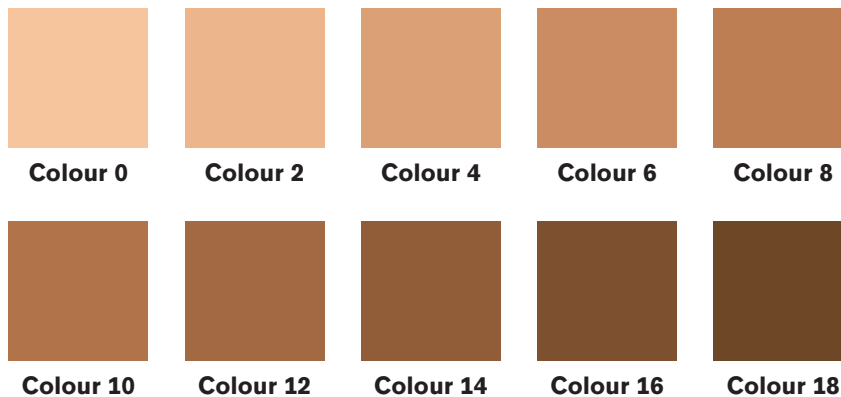

1

2

3

4

5

6

7

8

9

10

11

12

13

14

1

2

3

4

5

6



99B16 Nylon Knee Stockings

The nylon knee stockings with rubberised cuff are intended as exterior cosmetic covers for modular transtibial prostheses.

Order example

Reference number	=	Size	Colour
99B16	=	1	B

Reference number	99B16		
Size	1	2	3
Length	~ 38.5 cm	~ 40.5 cm	~ 44.5 cm
Foot length	~ 17.5 cm	~ 18.5 cm	~ 19 cm
Ankle (1/2)	~ 9 cm	~ 9.2 cm	~ 9.25 cm
Cuff (1/2)	~ 11.5 cm		
Colour	skin colour (-), brazil (B)		



skin colour



brazil

7

8

9

10

11

12

13

14



99B14 Nylon Cosmetic Stockings

The nylon cosmetic stockings with rubberised cuff are intended as exterior cosmetic covers for modular knee disarticulation and transfemoral prostheses.

Order example

Reference number	=	Size	Colour
99B14	=	1	B

Reference number	99B14				
Size	0	1	2	3	4
Length	~ 59 cm	~ 61.5 cm	~ 66 cm	~ 72 cm	~ 83.5 cm
Foot length	~ 18 cm	~ 19 cm	~ 20 cm	~ 20.5 cm	~ 21 cm
Ankle (1/2)	~ 9 cm			~ 9.25 cm	~ 9.5 cm
Cuff (1/2)	~ 15 cm	~ 16 cm	~ 17 cm	~ 18 cm	~ 19 cm
Colour	skin colour (-), brazil (B)				



skin colour



brazil

99B14=HE Nylon Cosmetic Stockings for hip disarticulation fittings

The 99B14=HE Nylon Cosmetic Stockings are intended as exterior cosmetic covers for modular hip disarticulation prostheses.

Article number	99B14=HE
Length	approx. 100 cm
Foot length	approx. 18.5 cm
Ankle (1/2)	approx. 10 cm
Cuff (1/2)	approx. 14 cm



99B15 Nylon Connector

The nylon connector is intended for fastening the foam cover on the transfemoral socket.

Order example

Reference number	=	Size
99B15	=	2

Reference number	99B15		
Size	1	2	3
Length	~ 22 cm		
Cuff (1/2)	~ 17 cm	~ 17.5 cm	~ 18 cm



99B17 Modular Knee Protector with elastic belt extension assist

Can be used in place of the 21B30 Modular Extension Assist

Article number	99B17
-----------------------	--------------



647G49

4R32 Finishing Kit for Modular Hip Disarticulation Prostheses

The finishing kit is used to secure the foam connection plate to the pelvic socket and is a functional component of the Ottobock modular hip joints.

Article number	4R32
Consisting of	2 connecting straps with ring 2 distal anchor rings 2 wedges 1 ThermoLyn Trolene strip (as lamination template) 1 pair nylon cosmetic stockings, skin colour, size 3



1

2

3

4

5

6

7

8

9

10

11

12

13

14



Exoskeletal Leg Prostheses

Exoskeletal prostheses, also called conventional or crustacean type prostheses, are commonly constructed of wood or plastic. The prosthesis walls provide shape and perform the weight bearing function.

This robust prosthesis type has been successfully used for years and may be the prosthesis of choice when user needs or geographical conditions contraindicate the use of modular components. All amputation levels except knee disarticulation may be fitted with an exoskeletal prosthesis.

The individual components are fabricated from a thick-walled material – wood or Pedilen – to allow custom alignment. The components are first placed in the alignment apparatus with the prosthetic socket and then temporarily connected to one another.

Modifications may be made during trial fitting; however, the components must be separated for this purpose. Modification of the static alignment is only possible to a very limited extent in the finished prosthesis.

In finishing the wooden prosthesis, one reduces the wall thickness of the components from the inside and shapes the outside. The ensuing lamination provides additional strength to the prosthesis while also creating an attractive surface.

To finish a plastic prosthesis, the model is laminated once the outer shape has been created. Pedilen rigid foam is then removed to produce a thin-walled, laminated prosthesis.

1

The physical arrangement of the knee-calf components and feet follows the approach for modular components.

We recommend using the 743A3 Alignment Apparatus for the correct and straightforward alignment of exoskeletal lower limb prostheses.

2

The recommended posterior placement values refer to the alignment reference line (graphic). Take into account a general exterior rotation of 5° for the knee axis of the various components.

3

4

5

6

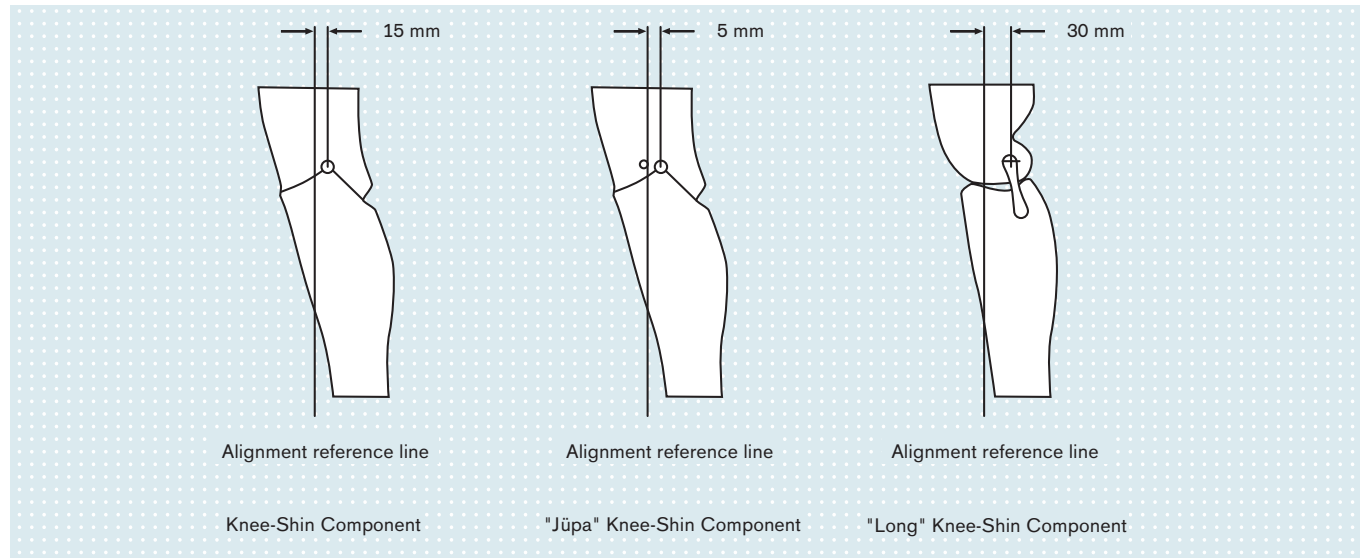

7

8

9

10

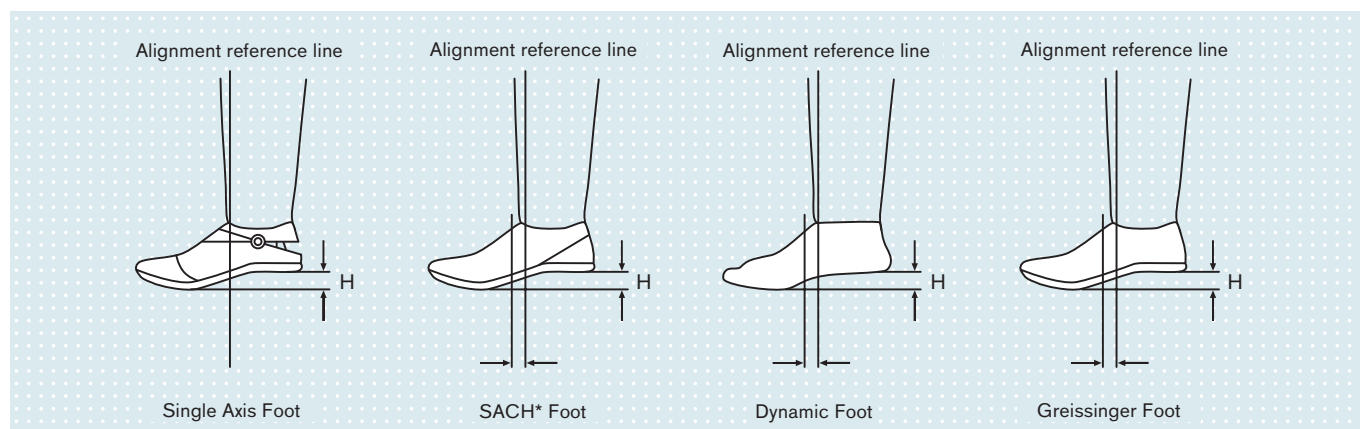

11

Please consult the respective instructions for use to find the alignment values for the various prosthetic feet. A safety factor is added to the effective heel height to compensate for the compression of the Pedilan sole, the dorsal stop and the knee joint stop.

12

The following values are added to the effective heel height:

for Single Axis Foot and SACH* Foot = $H + 5 \text{ mm}$

for Dynamic Foot and Greissinger Foot = $H + 10 \text{ mm}$

13

14

Foot Components

Ottobock offers five different types of foot components for use in exoskeletal prostheses:

- Cosmetic Light Foot
- SACH* Feet
- Dynamic Feet
- Single-Axis Feet
- Greissinger Feet (multiaxial)

The foot components are constructed according to the principles of the Ottobock alignment system. The wood, metal and plastic materials we use have been tested for years to perform reliably. The plastic components are fabricated according to formulas developed by Ottobock Kunststoff GmbH & Co., and have become known and valued worldwide under the names Pedilan and Pedilen. Pedilan – a vulcanised cellular plastic developed especially for orthopaedic applications – was first introduced by Ottobock in 1961.

With the Ottobock foot components, the heel height, ball shape and toe lift are all coordinated with the placement and function of the ankle joint. This in turn is in a specific relationship to the load line of the prosthesis. Therefore it is critical that the alignment recommendations be followed for the particular foot being used in order to achieve optimum function.



1

2

3

4

5

6

7

8

9

10

11

12

13

14

1

- The feet below can be used in modular prostheses and in exoskeletal prostheses. For detailed information, see the section "Modular Structure – Prosthetic Feet".

2

Cosmetic Light Foot



Cosmetic Light Foot

Article number	1G6
----------------	-----

3

4

5

SACH* Feet



SACH Foot with Toes and Sandal Toe

Reference number	1S90
------------------	------

6

7

8



1S49 SACH Foot with Toes

Reference number	1S49	1S66	1S67
------------------	------	------	------

9

10



11

12

13

14

Dynamic Feet

Dynamic Foot with Toes and Sandal Toe

Article number	1D10
----------------	------



Dynamic Foot with Toes and Sandal Toe

Article number	1D11
----------------	------



Accessories for Cosmetic Light Foot, SACH and Dynamic feet

2K34 Shaped Ankle Part

Without threaded bushing, for 1G6 and all SACH* and dynamic feet, to be used on the left or right side.

Without threaded bushing, for 1WR95 without adapter, to be used on the left or right side.

Article number	2K34=25	2K34=30
for foot sizes	24 – 25 cm	26 – 28 cm



- 1
- 2
- 3
- 4
- 5
- 6
- 7
- 8
- 9
- 10
- 11
- 12
- 13
- 14

1



2Z22 Screw Connection



2

3

4

5

Article number	2Z22=M10	2Z22=M8x90
for	1S90 (all sizes) 1S49 (all sizes) 1S66 (all sizes) 1S67 (26 cm) 1S101 (all sizes) 1S102 (all sizes) 1S103 (all sizes) 1D10 (all sizes) 1D11 (26 – 28 cm)	1G6 (all sizes) 1S67 (22 – 25 cm) 1D11 (22 – 25 cm)
Scope of Delivery	1 threaded bushing 1 cap screw 1 washer	1 threaded bushing 1 cap screw 1 washer

6



2F8 Pedilan Block

7

Article number	2F8=H	2F8=M	2F8=W
Dimensions	115×75×65 mm		
Hardness	hard	medium	soft

8



2U1 Elastic Foot Cover

9

Article number	2U1=L	2U1=R
Side	Left (L)	Right (R)
Size	universal	

10

11

12

13

14

Single Axis Foot

Single Axis Foot with Toes

Order example

Reference number	=	Side	Size
1H37	=	L	26

The 1H37 and 1H39 Single Axis Foot have different heel heights, with 2K14 Shaped Ankle Part and 2H19 Ottobock Single Axis Joint.

Reference number	1H37							
Heel height	10 mm							
Side	Left (L), Right (R)							
Size	21 cm	22 cm	23 cm	24 cm	25 cm	26 cm	27 cm	28 cm
Colour	beige							
Max. body weight	100 kg							

The 1H37 and 1H39 Single Axis Foot have different heel heights, with 2K14 Shaped Ankle Part and 2H19 Ottobock Single Axis Joint..

Reference number	1H39							
Heel height	25 mm							
Side	Left (L), Right (R)							
Size	22 cm	23 cm	24 cm	25 cm	26 cm	27 cm	28 cm	29 cm
Colour	beige							
Max. body weight	100 kg							



1H31 Single Axis Foot without Toes, two-parts

with 2K14 Shaped Ankle Part, 2H19 Ottobock Single Axis Joint and 2Z67 Pedilan Sole.

Order example

Reference number	=	Side	Size
1H31	=	L	26

Reference number	1H31							
Heel height	25 mm							
Sides	left (L), right (R)							
Size	22 cm	23 cm	24 cm	25 cm	26 cm	27 cm	28 cm	29 cm
Colour	beige/white							
Max. body weight	100 kg							



1

2

3

4

5

6

7

8

9

10

11

12

13

14

1

Single Components for Single Axis Feet as Spare Parts

2



1H38 Single Axis Foot with Toes

Reference number	1H38	1H40
as	Single component of the 1H37 Single Axis Foot with Toes	Single component of the 1H39 Single Axis Foot with Toes

4



1H32 Single Axis Foot without Toes, 2-piece

Reference number	1H32
as	Single component of the 1H31 Single Axis Foot

5

6

7



2H19 Ottobock Single Axis Joint (5)

maintenance-free, complete (without rubber bumper)

Article number	2H19=42	2H19=47
for foot sizes	21 – 24 cm	25 – 29 cm
Weight	200 g	206 g

8

9

10

2D5 Single Component Pack for Single Axis Feet

Article number	2D5
Scope of Delivery	1 lower joint bushing (1) 1 shell (2) 1 washer (3) 1 rubber bumper, hard, 59 mm long (4) 1 rubber bumper, medium, 54 mm long (4) 1 rubber bumper, soft, 42 mm long (4)

11

12

13

14

2K14 Shaped Ankle Part

for single axis feet with encased joints

Order example

Reference number	=	Side	Size
2K14	=	L	26

Reference number	2K14							
Side	Left (L), Right (R)							
Size	22 cm	23 cm	24 cm	25 cm	26 cm	27 cm	28 cm	29 cm



709S14=11 Allen Wrench

galvanised, with mandrel, for Ottobock single axis joint

Article number	709S14=11
Material	
Length	120 mm
for	502S17=M7 Nut
Weight	0.077 kg
To be used for	



709S3 Square Socket Wrench, long

painted black

Article number	709S3
Material	Round bar steel
Length	530 mm
for	502V5=M10X1 Nut
Weight	0.450 kg
Colour	black



1

2

3

4

5

6

7

8

9

10

11

12

13

14

1

Greissinger Foot

2



1A6 Greissinger Foot

with 2K5 Shaped Ankle Part, joint movable in all directions, 2Z18 Pedilan Toe, 2F18 Pedilan Heel Wedge and 2Z14 Pedilan Sole, sole contour flat

Order example

Reference number	=	Side	Size
1A6	=	L	26

3

4

5

Reference number	1A6				
Heel height	28 mm				
Side	Left (L), Right (R)				
Size	25 cm	26 cm	27 cm	28 cm	29 cm
Colour	wood colour/white				
Max. body weight	100 kg				

6

Single Components for Greissinger Foot as Spare Parts

7



1A7 Greissinger Shaped Foot Part

with 2Z18 Pedilan Toe, 2F18 Pedilan Heel Wedge and 2Z14 Pedilan Sole, sole contour flat

Order example

Reference number	=	Side	Size
1A7	=	L	26

8

9

Reference number	1A7				
Side	Left (L), Right (R)				
Size	25 cm	26 cm	27 cm	28 cm	29 cm

10



2Z18 Pedilan Toe

Order example

Reference number	=	Side	Size
2Z18	=	L	26

11

12

Reference number	2Z18				
Side	Left (L), Right (R)				
Size	25 cm	26 cm	27 cm	28 cm	29 cm
for	1A6 1A7				

13



2F18 Pedilan Heel Wedge

Article number	2F18				
for	1A6 1A7 Sizes 25 to 29 cm				

14

2Z14 Pedilan Sole

Sole contour flat

Order example

Reference number	=	Side	Size
2Z14	=	L	26

Reference number	2Z14				
Side	Left (L), Right (R)				
Size	25 cm	26 cm	27 cm	28 cm	29 cm
for	1A6 1A7				



1

2

3

4

Single Component Pack

Article number	2D1	2D2
Size	24 – 25 cm	26 – 29 cm
for	1A6 1A29	
Scope of Delivery	1 of each rocking rubber soft, medium, hard 1 attachment pin 1 flexible joint retainer 1 two hole washer 2 attachment bolts 1 washer 1 lock nut	



5

6

7

2S22 Lower Joint Section

U-Joint

Article number	2S22=68	2S69=68
Material	Steel	Titanium
Size range	25 – 29 cm	25-29 cm



8

9

2K5 Shaped Ankle Part

Order example

Reference number	=	Side	Size
2K5	=	L	26

Reference number	2K5				
Side	Left (L), Right (R)				
Size	25 cm	26 cm	27 cm	28 cm	29 cm
for	for 1A6, with 2S4 Attachment Pin and 2S18 Plastic Insert				



10

11

12

709S7 Allen Wrench

Article number	709S7		
Suitable for	Lock nut		



13

14

1

2

3

4

5

Greissinger plus

1A29 Greissinger plus

with 2K25 Shaped Ankle Part and joint movable in all directions.

Order example

Reference number	=	Side	Size
1A29	=	L	26



647H205

Reference number	1A29					
Heel height	10 mm					
Side	Left (L), Right (R)					
Size	24 cm	25 cm	26 cm	27 cm	28 cm	29 cm
Colour	beige					
Max. body weight	75 kg			100 kg		

6

Single Components for Greissinger plus as Spare Parts

7

1A31 Greissinger plus Shaped Foot Part without Adapter

Order example

Reference number	=	Side	Size
1A31	=	L	26



Reference number	1A31					
Side	Left (L), Right (R)					
Size	24 cm	25 cm	26 cm	27 cm	28 cm	29 cm
Max. body weight	75 kg			100 kg		

9

10

2K25 Shaped Ankle Part

Order example

Reference number	=	Side	Size
2K25	=	L	26



Reference number	2K25					
Side	Left (L), Right (R)					
Size	24 cm	25 cm	26 cm	27 cm	28 cm	29 cm
for	1A29					

12

13

14

Single Component Pack

Article number	2D1	2D2
Size	24 – 25 cm	26 – 29 cm
for	1A6 1A29	
Scope of Delivery	1 of each rocking rubber soft, medium, hard 1 attachment pin 1 flexible joint retainer 1 two hole washer 2 attachment bolts 1 washer 1 lock nut	



Pirogoff Foot

1P9 Pirogoff Foot

Order example

Reference number	=	side	size
1P9	=	L	26

Reference number	1P9					
Heel height	10 mm					
Side	Left (L), Right (R)					
Size	23 cm	24 cm	25 cm	26 cm	27 cm	28 cm
Colour	wood colour/beige					



 647H130

- We recommend 636W25 PU Adhesive with 636W26 Hardener to bond the mid-foot to the foot component.

1

2

3

4

5

6

7

8

9

10

11

12

13

14

1

2

3

4



Knee-Calf Components

Decades of experience have gone into the design of Ottobock knee-calf components. The components correspond to the static and dynamic guidelines of the Ottobock alignment system. Regardless of the type of material used – wood or Pedilen – the Ottobock knee-calf components have a thick-walled design. This allows them to be oriented as desired in the 3 planes during alignment. They also facilitate production of an attractive shape while allowing hollowing from the interior, in order to achieve the thinnest walls and lightest weight possible.

The joints that are integrated into the knee-calf components are precision built. They are known for their simple construction, reliable performance, minimal weight, easy maintenance and long-term durability. The use of standard parts ensures the quick exchange of components.

5

6



3P19 Knee-Calf Component, single-axis

with standard extension stop frame, constant friction unit and closed knee ball

Order example

Reference number	=	Side	Calf circumference
3P19	=	L	32

Reference number	3P19
Material	Poplar
Calf circumference	28 cm, 30 cm, 32 cm, 34 cm, 36 cm, 38 cm, 40 cm
Side	Left (L), Right (R)

7

8

9

Accessories

- Order separately as necessary.

10



726W11 Tapered Reamer

for reaming out worn knee axis bushings

Article number	726W11
for	3P19 and 3P23 Knee Axis Bushing
Weight	24,5 kg

11

12

13

14



Single Components as Replacement Parts

4H14 Standard Extension Stop Frame

with stop bumper, hard

Article number	4H14
-----------------------	-------------

4V71 Constant Friction Unit

Article number	4V71
-----------------------	-------------



1

3D6 Single Component Pack

Article number	3D6
for	3P19
Consisting of	1 knee axis with knee axis screw (stainless steel) (1) 1 washer (2) 1 oval head countersunk screw, slotted (3) 2 knee axis bushings (4)



2

3

4

3P23 Jüpa Knee-Calf Component

The knee joint with friction brake offering a high level of wearer comfort thanks to outstanding functional characteristics:

Reliable stance phase control, weight activated by a wedge and groove configuration. With constant friction unit and internal extension assist for individual swing phase control.

Order example

Reference number	=	Side	Calf circumference
3P23	=	L	30

Reference number	3P23
Material	Poplar
Calf circumference	28 cm, 30 cm, 32 cm, 34 cm, 36 cm, 38 cm, 40 cm
Side	Left (L), Right (R)



5

6

7

8

Accessories

- Order separately as necessary.

726W11 Tapered Reamer

for reaming out worn knee axis bushings

Article number	726W11
for	3P19 and 3P23 Knee Axis Bushing
Weight	24,5 kg



10

11

12

13

14

1

Single Components as Replacement Parts

2

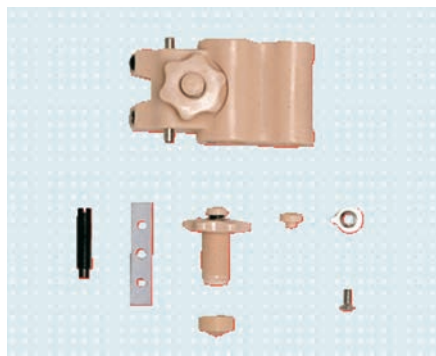

4B52 Swing Block

Article number	4B52
-----------------------	-------------

3

4

5



3D4 Single Component Pack

Article number	3D4
for	3P23
Consisting of	1 knee axis with knee axis screw (stainless steel) (1) 1 swing axis pin (2) 2 knee axis bushings (3) 1 extension assist bow (4) 1 deceleration bumper (5) 1 knee extension stop rubber (6) 1 shin extension stop bumper (7)

6

7



4V21 Friction Segment

Order example

Reference number	=	thickness
4V21	=	2.5

8

9

Reference number	4V21
Thickness	2 mm 2,5 mm 3 mm

10

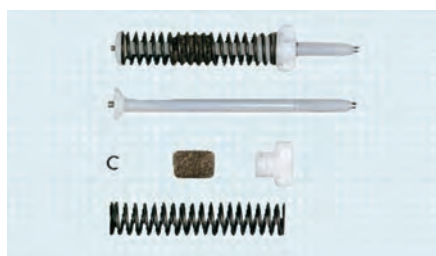

4V89 Extension Assist, pre-assembled

Article number	4V89
-----------------------	-------------

11

12

13

14

3P4 Knee-Calf Component

single axis, with central lock and extension stop frame

Order example

Reference number	=	Side	Calf circumference
3P4	=	L	30

Reference number	3P4
Material	Poplar
Calf circumference	28 cm, 30 cm, 32 cm, 34 cm, 36 cm, 38 cm, 40 cm
Side	Left (L), Right (R)



647H254

Single Components as Replacement Parts

4H12 Extension Stop Frame

with riveted guide plate

Order example

Reference number	=	Side
4H12	=	L

Reference number	4H12
Side	Left (L), Right (R)



3D1 Knee Locking Unit

Article number	3D1
for	3P4
Consisting of	1 locking bolt 1 locking lever 1 compression spring 1 plastic guide, left 1 plastic guide, right 1 slotted nut 1 ball head nut

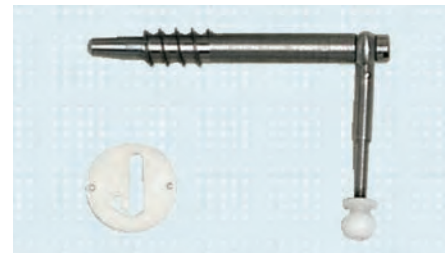

3D2 Single Component Pack

Article number	3D2
for	3P4
Consisting of	1 knee axis with knee axis screw (stainless steel) (1) 2 repair knee axis bushings (2) 2 oval head screws (3) 2 square nuts (4)



1

2

3

4

5

6

7

8

9

10

11

12

13

14

1
2
3
4
5
6
7
8
9
10
11
12
13
14

Socket Blocks

Only flawless poplar wood is chosen for Ottobock socket blocks: step-by-step and long-term drying, special preparation against cracking, water and perspiration-resistant bonding. When used in combination with our knee-calf components, the transfemoral socket blocks are sufficiently long.



6P1 Transtibial Socket Block

two-piece

Article number	6P1
Material	Poplar

- The wooden socket can also be copied by Ottobock Service Fabrication. For more information, please consult the 646K71=D Service Catalogue.



5P1 Transfemoral Socket Block

Article number	5P1=1	5P1=2	5P1=3
Residual limb circumference	530 – 620 mm	450 – 560 mm	370 – 480 mm
Dimensions (DxWxH)	250x260x370 mm	210x220x370 mm	190x200x370 mm
Material	Poplar		

- The wooden socket can also be copied by Ottobock Service Fabrication. For more information, please consult the 646K71=D Service Catalogue.

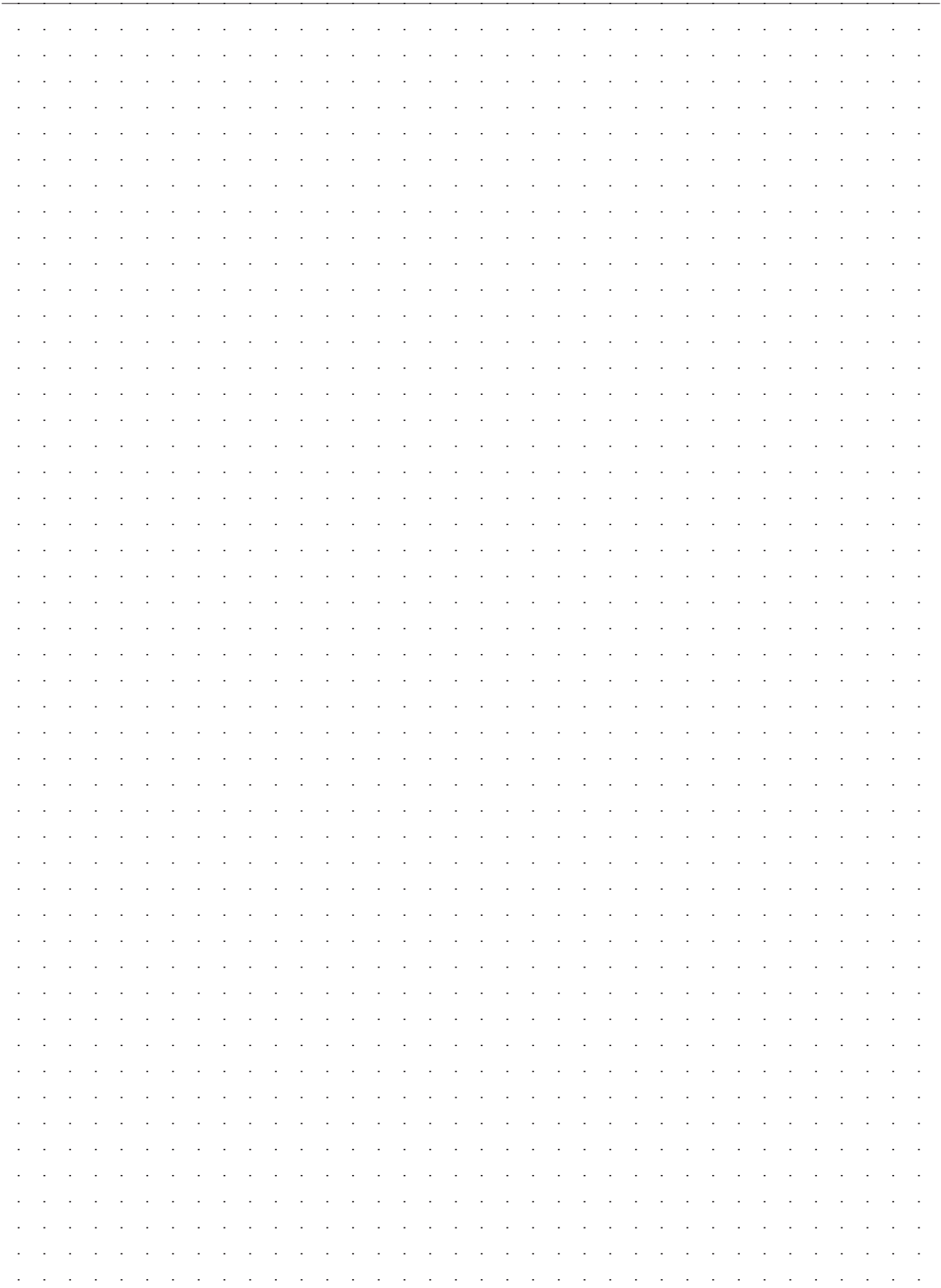

1
2
3
4
5
6
7
8
9
10
11
12
13
14

1

2

3

4

5

6

7

8

9

10

11

12

13

14

Article Number Index

For easy ordering, the following pages contain order forms for the products contained in this catalogue. These forms can be duplicated.

1

2

3

4

5

6

7

8

9

10

11

12

13

14

1

2

3

4

5

6

7

8

9

10

11

12

13

14

3		Connection Cap	84, 87, 100, 104, 106, 109, 129, 133, 137	1
30 mm pylon with titanium clamp adapter	141	Connection Plate	80, 89	2
A		Constant Friction Unit	319	3
Accessory Kit	72	Cosmetic Light Foot	308	4
ACS Cold Weld Material	289	Cotton Residual Limb Sock	284	5
Adapter Plate	74, 154	Custom Silicone Gel Liner	250	6
Adjust	93 f	Custom Silicone Liner from a plaster cast	250	7
Adjustment Adapter	58	D		8
Adjustment Wrench	62, 188	DeltaTwist	174	9
Advantage DPII	127	Derma Clean	251	10
AKquire PUR Liner	245	Derma Prevent	251	11
Allen Wrench	313, 315	Derma ProFlex Sealing Sleeve	262	12
Anatomic 3D PUR Liner	243	Derma Protection Sealing Sleeve	262	13
Aqua-Foot with Modular Adapter	63	Derma Repair	251	14
Aqua-Foot without Adapter for Exoskeletal Design	63	Derma Seal	282	
Aqua-Knee	62	Derma Seal Double Forte	283	
AXON Tube Adapter	217	Derma Seal Forte	282	
Axtion	107 f	Derma Seal Trans Ped	283	
Axtion DP	124 f	Derma Travel Set	251	
B		Derma Trial Set	252	
Bag	259	Distal Air Chamber	288	
Balance TPE Liner	246	Donning Spray for Silicone Liners	253	
Basic SIL Liner	67, 240	Dorsal Stop Set	84, 87	
Basic TPE Liner	247	Double Adapter	150 f	
Battery Charger	213	Dynamic Foot	90 f	
BionicLink	212	Dynamic Foot with Adapter	90	
BionicLink PC	212, 218	Dynamic Foot with Toes and Sandal Toe	309	
C		Dynamic Motion	99	
C-Leg compact Knee Joints	210	E		
C-Leg Knee Joints	206, 208	Elastic Foot Cover	310	
C-Leg Protector	211	End Bearing Cushion	54	
C-Leg Tube Adapters	209 f	Exhaust Tubing	259	
C-Soft – Auto-Adaptive Software	212	Extension Assist	320	
C-Sprint	74	Extension Stop Frame	321	
C-Walk	105	F		
Charger Extension Cable	213	Fill Footshell Foam Kit	42, 133	
Chopart Bonding Kit	42, 133	Filter	259	
Chopart Footplate for Children	41	Finishing Kit for Modular Hip Disarticulation Prosthesis	214, 303	
ClickValve	275	Fitness	71	
ClickValve Base	276	Flat Rubber Valve	278 f	
ClickValve Safety Leash	276	Flat Silicone Valve	278	
Connecting tube with seat ring	279	Flexible Foam	50	
Connection Adapter	151	Flexible Pin for MagnoFlex Lock	269	

1	Foam Connecting Cap	82	Knee-Shin Component for Children	49
	Foam Connection Cap	98	Knee Forming Cover	62
	Foam Cover	295 ff	Knee Locking Unit	321
2	Foam cover for hip disarticulation fittings	300	L	
	Foot Adapter with Screw Connection	38, 80	Lamination Anchor	135
	Footshell 95, 103, 106, 108, 112, 129, 133, 135, 137		Lamination Anchor with Pyramid Adapter	64, 155 ff
3	Footshell for Children	41	Lamination Anchor with Pyramid Receiver	44, 64, 156 ff
	Footshell Replacement Tool	129	Lamination Anchor with Threaded Connector	156 f
4	Frame Socket	54	Lamination Disc	162, 270
	Friction Segment	320	Lamination Dummy	158, 169
	Functional ring	116	Lamination Plate	224, 227, 235
	Functional Ring for Harmony P3	119, 256	Lamination Set	273
	Fuse Link	258	Lateral Air Chamber	288
5	G		Latex Casting Bags	258
	Gate training DVD	235	Light Metal Tube	229 f
	Genium Knee Joints with Remote Control	217	Liner Fit Kit	260
6	Greissinger Foot	314	Locking Unit	184, 202
	Greissinger plus	97, 316	Lock Slide	188
	Greissinger Shaped Foot Part	314	Lo Rider	136
7	H		Lower Joint Section	315
	Harmony Complete Installation Kit	260	Lubricating Cream	261
	Harmony Custom Liner	248	M	
	Harmony E2	257	MagnoFlex Lock	268
8	Harmony P2	255	MagValve	275
	Harmony P3	255	MagValve Upper Section	276
	Harmony P3 Service Set	256	Manometer with Inflatable Ball	55
9	Harmony Sealing Sleeve	263	Modular Friction Brake Knee Joint with Lock	187
	Harmony System HD	257	Modular Hip Joint	48
	Harmony Vacuum Pump Set	258	Modular Knee Joint	45 ff, 189 f, 200, 202, 204 f
10	Heel Wedge	108	Modular Knee Protector	303
	Heel Wedges for 1C60 Triton	113	Modular Lightweight Single Axis Knee Joint	182
	Helix ^{3D} Hip Joint	232	Modular Monocentric Hip Joint	222 f
11	J		Modular Monocentric Knee Joint	185, 198
	Jüpa Knee-Calf Component	319	Modular Polycentric EBS Knee Joint	194
12	K		Modular Polycentric Knee Joint	186, 192, 201
	KISS 4-Hole Base	273	Modular Single Axis Knee Joint	183
	KISS Delrin Base	273	Modular Transtibial and Transfemoral Sets	166
	KISS Distal Straps	273	Modular Transtibial Sets	165, 167
13	KISS Lanyard Systems	272	Monocentric hip joint	226
	KISS Proximal Nut and Screw	273	N	
	KISS Proximal Straps	273	Nylon Connector	303
14	Kit for Halmstad Interim Prosthesis	56	Nylon Cosmetic Stockings	50, 302 f
	Knee-Calf Component	318, 321	Nylon Knee Stockings	302

Nylon Protective Sleeve	285	PVC Connection Tube	279	1
Nylon Residual Limb Sock for liners with connection	284	PVC Suction Hose	258	
O				
O-Ring for ClickValve	276	Pyramid Adapter with Threaded Connector	153, 158	2
O-Ring for ClickValve Upper Valve Part	276	Pyramid Receiver with Threaded Connector	153, 158	
P				
One-way Valve	280	R		
Ottobock Dynamic Foot for Children	37	Reference Determination Tool	227	3
Ottobock Modular Monocentric Locking Knee Joint	181	Reinforcement Strips	273	
Ottobock SACH Foot for Children	37	Rollover Contour with Spikes	74	
Ottobock Single Axis Joint	312	Rotation Adapter	168 f, 229	4
S				
PC Interface with USB Connection Cable	213	SACH Foot for Children	36	5
Pedilan Block	310	SACH Foot with Toes	308	
Pedilan Heel Wedge	314	SACH Foot with Toes and Sandal Toe	308	6
Pedilan Light Foot with Toes	80	Screw Connection	39, 81, 92, 310	
Pedilan Single Axis Foot	81	Screw Set	135	7
Pedilan Sole	315	Screw to secure the knee forming cover	62	
Pedilan sole with heel wedge for 1S30	36	Screw Valve	278	8
Pedilan Toe	314	Seat Ring	279	
Pedilin Cone for Soft Socket	289	Setting Aid with Screw	135	9
Pin	67, 270	Shaped Ankle Part	39, 309, 313, 315 f	
Pirogoff Foot	317	ShapePlus Custom PUR Liner	249	10
Plug Holder for Charger Extension Cable	213	Shuttle Lock	66, 266 f	
Pneumatic End Bearing Cover	55	Shuttle lock with adjustment screw	266	11
Pneumatic Transfemoral Cover	54	Shuttle Lock with Pyramid Adapter	266 f	
Polycentric Knee Joint	191, 196	Single Axis Foot Adapter with Screw Connection	81	12
Posterior Connection Plate	73, 128	Single Axis Foot without Toes	311 f	
Power Supply	213	Single Axis Foot with Toes	312	13
Procomfort Gel	290	Single Component Pack	45 ff, 66, 96, 98, 182 ff, 193, 200 f, 203 ff, 315, 317, 319 ff	
Procomfort Inner Socket	289	Single Component Pack for sealing sleeve	188	14
Profile PUR Liner	244	Single Component Pack for Single Axis Feet	82, 84, 87, 312	
ProSeal Custom SIL Liner	250	Single components pack	223, 225	15
ProSeal Ring	241, 263	Slider Plate for MagnoFlex Lock	268	
ProSeal SIL Liner	241	Sliding Adapter	57, 153	16
ProSymes	134	Sliding Adapter Set	58	
Protective Plug for C-Leg	214	SL Profile for Children	41	17
Protective Sleeve	185	Socket Band for C-Leg Protector	211	
Protective Sock	109, 129, 137	Socket Adapter	44	18
Protector Closure Kit	211	Socket Adapter with Pyramid Adapter	160	
PU Hose	289	Socket Adapter with Pyramid Receiver	161	19
Pull Cable	188	Socket Attachment	163	
PUR Custom Liner	248	Socket Attachment Block	44, 162, 269	20
PUR Custom Liner for transfemoral fittings	249	Socket Attachment for Thermoplastic Socket	56, 163	
PushValve	67, 275	Socket Connector	261	21
PushValve Upper Section	276			

1	Socket Mounting Plate	162, 270	V4 Valve	281
	SoftTouch Stockings for Transtibial Prostheses	301	V5 EasyLine Valve Kit	280
	Special Scissors for Cutting Synthetic Fabrics	253	V5 Valve	281
2	Spike sole	72	Vacuum Connector	261
	Spots	260	Vacuum Pump	258
	Springlite II	128	Valve for shuttle lock	268
	Springlite II for Children	39	Valve Set	277 f
3	Sprinter	72 f	W	
	Square Socket Wrench	313	Water Trap	258
	Standard Extension Stop Frame	318	Woolen Residual Limb Sock	285
4	Standard Pro SIL Liner	240	X	
	Sticky Spots	260	X-Soft – Auto-Adaptive Software	218
	Swing Block	320	XO Coupler	136
5	T			
	T-Adapter	73, 128		
	Tapered Reamer	49, 318 f		
6	Terry Cloth Covers	289		
	Terry Cloth Residual Limb Sock	284 f		
	TF Adapt Custom Silicone Liner	250		
	TF Definitive Fitness Foot Adapter	71		
7	TF Test Fitness Foot Adapter	71		
	Thigh Support Bandage	264		
	Threaded Hose Nozzle	258		
	Threaded Valve Set	277		
8	Three-Way Valve	288		
	Tool	163		
	Torsion Adapter	170 ff		
9	Transfemoral Socket Block	322		
	Transtibial Socket Block	322		
	Trias	101 f		
	Triton	110		
10	Triton Harmony	117		
	Triton Heavy Duty	122		
	Triton Low Profile	120		
	Triton Vertical Shock	114 f		
11	Tube Adapter	43, 57, 65, 140 f, 146, 199		
	Tube Adapter Selection Plate	213 f		
	Tube Clamp Adapter	43, 66, 143 ff, 147 f, 224, 227 f		
12	Tube Protector Set	211		
	Two hole pin wrench for 21Y14	277		
13	U			
	Universal sole with running shoe tread	72		
14	V			
	V4 EasyLine Valve Kit	280		

Article/Reference No	Page	Article/Reference No	Page	Article/Reference No	Page
1					
1A6	314	1H34	85	2D7	81, 92
1A7	314	1H37	311	2D7=M10	89
1A29	316	1H38	83, 312	2D11	96
1A30	97	1H39	311	2E3	41
1A31	97, 316	1H40	83	2F8	310
1C2	74	1K10	37	2F18	314
1C20	134	1K30	37	2F20	108
1C30	101, 102	1M10	93, 94	2F60	113
1C40	105	1P9	317	2G120	135
1C60	110, 111	1S30	36	2H19	312
1C61	114, 115	1S49	308	2K5	315
1C62	117	1S90	308	2K14	313
1C63	120, 121	1S101	88	2K25	316
1C64	122, 123	1S102	88	2K34	309
1D10	90, 309	1S103	88	2K36	39
1D11	91, 309	1WR95	63	2R2	141, 142
1D35	99			2R3	141, 142
1E50	126, 127	2		2R14	80, 89
1E51	126	2C1	93, 95	2R20	217
1E56	107, 108	2C2	135	2R21	217
1E57	136	2C3	101, 103	2R22	84, 87
1E58	124, 125	2C4	106	2R30	229
1E61	128	2C5	108, 129, 133, 137	2R33	84, 87
1E66	39	2C6	110, 112, 114, 117, 120, 122	2R36	230
1E79	41	2C10	100, 109, 129, 133, 137	2R37	140, 142
1E80	132	2C11	100, 106	2R38	140, 142
1E81	132	2C19	95, 104, 112	2R38=5	141
1E82	132	2C20	95, 104, 112	2R38=10	141, 142
1E87	41	2C100	129	2R40	38
1E90	72, 73	2D1	315, 317	2R41=1	43, 44
1G6	80, 308	2D2	315, 317	2R41=2	43, 44
1G9	81	2D3	98	2R45=34	57, 59
1H31	311	2D4	98	2R45=S	57, 59
1H32	85, 312	2D5	82, 84, 87, 312	2R48	43, 44
		2D6	38	2R49	140, 142
		2D6=M10	89	2R50	140, 142

1

Article/Reference No	Page
2R51	81

2

2R54	80, 89, 91
------	------------

2R57	146
------	-----

2R58	146, 199
------	----------

3

2R63	82
------	----

2R76	146
------	-----

2R77	146, 199
------	----------

4

2R80	210
------	-----

2R82	209
------	-----

2R86	98
------	----

5

2R102	165
-------	-----

2R103	167
-------	-----

2R105	166
-------	-----

6

2R111	74
-------	----

2R117	261
-------	-----

2R119	261
-------	-----

7

2R120	165
-------	-----

2R121	165
-------	-----

8

2R122	166
-------	-----

2R123	167
-------	-----

2R124	167
-------	-----

9

2R125	167
-------	-----

2R176=T	73, 128
---------	---------

10

2S22	315
------	-----

2S88	84, 87
------	--------

2U1	310
-----	-----

11

2WR95	65
-------	----

2WR95=1	65
---------	----

2Z14	315
------	-----

12

2Z18	314
------	-----

2Z22	39, 310
------	---------

2Z25	36
------	----

13

2Z64	86
------	----

2Z67	86
------	----

2Z120	135
-------	-----

14

2Z285	74
-------	----

Article/Reference No	Page
2Z328	135

2Z500	72
-------	----

2Z501	72
-------	----

3

3B1	217
-----	-----

3C96-1	210
--------	-----

3C98-2	206, 208
--------	----------

3C98-2=7.1	207
------------	-----

3D1	321
-----	-----

3D2	321
-----	-----

3D4	320
-----	-----

3D5	49
-----	----

3D6	319
-----	-----

3P4	321
-----	-----

3P19	318
------	-----

3P21	49
------	----

3P23	319
------	-----

3R6	296
-----	-----

3R15	185
------	-----

3R17	183
------	-----

3R20	186
------	-----

3R21	204
------	-----

3R23	202
------	-----

3R24	297
------	-----

3R30	204
------	-----

3R32	202
------	-----

3R33	183
------	-----

3R36	186
------	-----

3R38	46
------	----

3R39	45
------	----

3R40	182
------	-----

3R41	181
------	-----

3R46	205
------	-----

3R48	50
------	----

3R49	185
------	-----

Article/Reference No	Page
3R55	201

3R60	194
------	-----

3R60-PRO	196
----------	-----

3R65	47
------	----

3R66	46
------	----

3R78	191
------	-----

3R80	198
------	-----

3R90	189
------	-----

3R92	190
------	-----

3R93	187
------	-----

3R95	200
------	-----

3R106	192
-------	-----

3S26	299
------	-----

3S27	300
------	-----

3S80	71
------	----

3S106	296
-------	-----

3S107	299
-------	-----

3S124	298
-------	-----

3WR95	62
-------	----

4

4B52	320
------	-----

4D1	185
-----	-----

4D3	193
-----	-----

4D7	204
-----	-----

4D9	203
-----	-----

4D10	183
------	-----

4D11	184
------	-----

4D13	186
------	-----

4D15	46
------	----

4D16	182
------	-----

4D17	47, 200
------	---------

4D18	205
------	-----

4D19	201
------	-----

4D20	45
------	----

4D27	66
------	----

Article/Reference No	Page	Article/Reference No	Page	Article/Reference No	Page
4D29	188	4R63	155	4R112	58, 59
4E50-2	213	4R63=5	155	4R116	157
4F18=N	188	4R63=5.1	155	4R118	154
4F34	184, 202	4R66	43, 44	4R119	158
4G650	188	4R68	155	4R120	174, 176
4G685	62	4R69	143, 145	4R121=30	174, 176
4G791=KIT	72	4R69=5	143	4R121=34	174, 176
4H12	321	4R72	150, 152	4R128-1	260
4H14	318	4R72=D	151	4R136=EL	280
4R1	58, 59	4R72=D-62	151	4R138	281
4R21	143, 145	4R73	160	4R138=EL	280
4R21=1	143	4R74	160	4R140	280
4R21=5	143	4R75=D-70	151	4R142	281
4R22	161	4R76	150	4R144	255
4R23	160	4R77	160, 161	4R147	255
4R32	224, 303	4R78	150	4R150	257
4R37	161	4R82	147, 149	4R152	257
4R39	171, 172	4R82=P	147, 149	4R156	148, 149, 228
4R40	171, 172	4R84	151	4R160=1	272
4R41	156	4R84=D	151	4R160=2	272
4R42	155	4R84=D-62	151	4R161	273
4R42=5	155	4R85	170, 172	4R163	273
4R43	156	4R86	171, 172	4R164	273
4R44=L	153, 154	4R87	158	4R165	273
4R44=N	158	4R88	148, 149	4R166	273
4R50	153, 154	4R89	156	4R167	273
4R51	161	4R91	147, 149	4R201	166
4R52	143, 145, 227	4R95	161	4R204	71
4R52=1	143	4R98	144, 145	4R206	71
4R54	160	4R100	155	4R420	73, 128
4R54=5	160	4R101	57, 59, 153, 154	4V21	320
4R55	161	4R103	144, 145	4V71	319
4R56	145, 224, 228	4R104	150	4V89	320
4R57	168, 169, 229	4R110	44	4WR95=1	64
4R57=ST	168, 169	4R111	157	4WR95=2	64
4R60	44	4R111=N	157	4WR95=3	66

1

Article/Reference No	Page
4X1	218

4X46	158
------	-----

2

4X46=ST	169
---------	-----

4X50	62
------	----

4X73	214
------	-----

3

4X77=D	213
--------	-----

4X77=GB	214
---------	-----

4X78	213
------	-----

4

4X79	213
------	-----

4X83=430-USB	213
--------------	-----

5

4X147	119, 256
-------	----------

4X148	256
-------	-----

4X160	211
-------	-----

6

4X177	211
-------	-----

4X178	211
-------	-----

4X180	212
-------	-----

7

4X202	211
-------	-----

4X225	273
-------	-----

4X260	116
-------	-----

8

5

5D1	288
-----	-----

5F1	289
-----	-----

5P1	322
-----	-----

10

5R1	162
-----	-----

5R2	162, 270
-----	----------

5R2=C	163
-------	-----

11

5R6	56, 163
-----	---------

5R9	44
-----	----

5S1	288
-----	-----

12

5S2	288
-----	-----

5T8	289
-----	-----

5Y14	163
------	-----

13

14

Article/Reference No	Page
----------------------	------

6

6A20=10	266, 271
---------	----------

6A20=20	266, 271
---------	----------

6A20=30	267, 271
---------	----------

6A30=10	267, 271
---------	----------

6A30=20	66, 267, 271
---------	--------------

6A40	268, 271
------	----------

6A41	268
------	-----

6A42	268
------	-----

6A43	269
------	-----

6A94	270
------	-----

6A94=3	162
--------	-----

6B3	56
-----	----

6K4	54
-----	----

6P1	322
-----	-----

6R6	295
-----	-----

6R7	50
-----	----

6R8	295
-----	-----

6R18	295
------	-----

6S1	55
-----	----

6S2	54
-----	----

6T2	289
-----	-----

6Y13=1	270
--------	-----

6Y13=2	270
--------	-----

6Y13=3	270
--------	-----

6Y13=F1	269
---------	-----

6Y13=L1	67, 270
---------	---------

6Y40	67, 240
------	---------

6Y42	240
------	-----

6Y70	239
------	-----

6Y70=M	250
--------	-----

6Y75	239
------	-----

6Y80	242
------	-----

6Y80=M	250
--------	-----

6Y81	241
------	-----

Article/Reference No	Page
----------------------	------

6Y81=M-2	250
----------	-----

6Y85	242
------	-----

6Y92	247
------	-----

6Y93	246
------	-----

6Y93F=C6	246
----------	-----

6Y400	248
-------	-----

6Y414	248
-------	-----

6Y416	249
-------	-----

6Y430	249
-------	-----

6Y510	244
-------	-----

6Y512	243
-------	-----

6Y522	245
-------	-----

6Y523	245
-------	-----

6Y540	245
-------	-----

7

7D2	225
-----	-----

7D3	48
-----	----

7D4	223
-----	-----

7D5	223
-----	-----

7E4	222
-----	-----

7E5	222
-----	-----

7E7	223
-----	-----

7E8	48
-----	----

7E9	226
-----	-----

7E10	232
------	-----

7Z53	224, 227, 235
------	---------------

7Z53=1-M10	227
------------	-----

20-99

21B37	264
-------	-----

21Y12	277
-------	-----

21Y14	67, 275
-------	---------

21Y14=S	276
---------	-----

21Y15	275
-------	-----

21Y15=S	276
---------	-----

Article/Reference No	Page	Article/Reference No	Page	Article/Reference No	Page
21Y21	275	451F11	286	683G1=1	258
21Y21=B	276	451F12	286	683G1=5	259
21Y41	279	451F13	287	683G1=10	258
21Y45	279	451F20	260	709S3	313
21Y70=N	185	451F21	285	709S7	315
21Y77	279	451U1	285	709S14=11	313
21Y81	278	451U9	285	710H10=2X3	188
21Y94	278	452A1	241, 263	719S20	253
21Y95	279	453A2	262	726W11	49, 318, 319
21Y96	277	453A3	262	743A29	227
21Y97	277	453A4	262	743D1	55
21Y105	278	453D2	283	755E20=230	258
21Y123	278	453D4	282	755Y16=1/4“X6	258
21Y140	278	453D5	283	755Z19=230	258
21Y222	277	453D7	282	755Z20=2	259
21Y230=0	276	453H1=1	261	756L10	253
21Y230=1	276	453H10	251	757L16-2	213
60X3	212	453H12	251	A-Z	
60X5	212, 218	453H14	251	SL=LR-XOCL-5/16	136
88L	250	453H30=GB	251	SL=LR-XOCL-M6	136
99B13	279	454A7	263	SL=LR-XOCS-M6	136
99B14	302	454A8	263	SL=P071	42, 133
99B14=HE	303	501S101=M4x12	62	SL=P078	42, 133
99B15	303	616R2=10X2	258	SL=Spectra-Sock	109, 129, 137
99B16	302	616R11=3.2X1.6X500	289		
99B17	303	616S132	260		
99B22	50	616S134	260		
99B23	54	625P1=1.0	258		
99B116	301	627F13=19x2	276		
400-800		627F13=24.5X3	276		
451F2	284	633S2	290		
451F3	284	634A61	289		
451F4	284	640F18	253		
451F6	285	646DV55	235		
451F10	287	646M453	252		
		662F2	259		

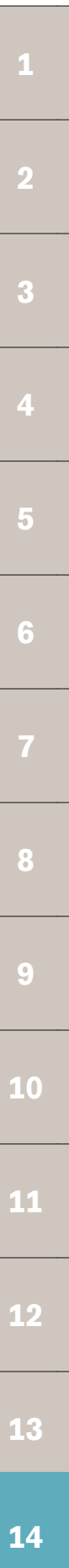

1	
2	
3	
4	
5	
6	
7	
8	
9	
10	
11	
12	
13	
14	

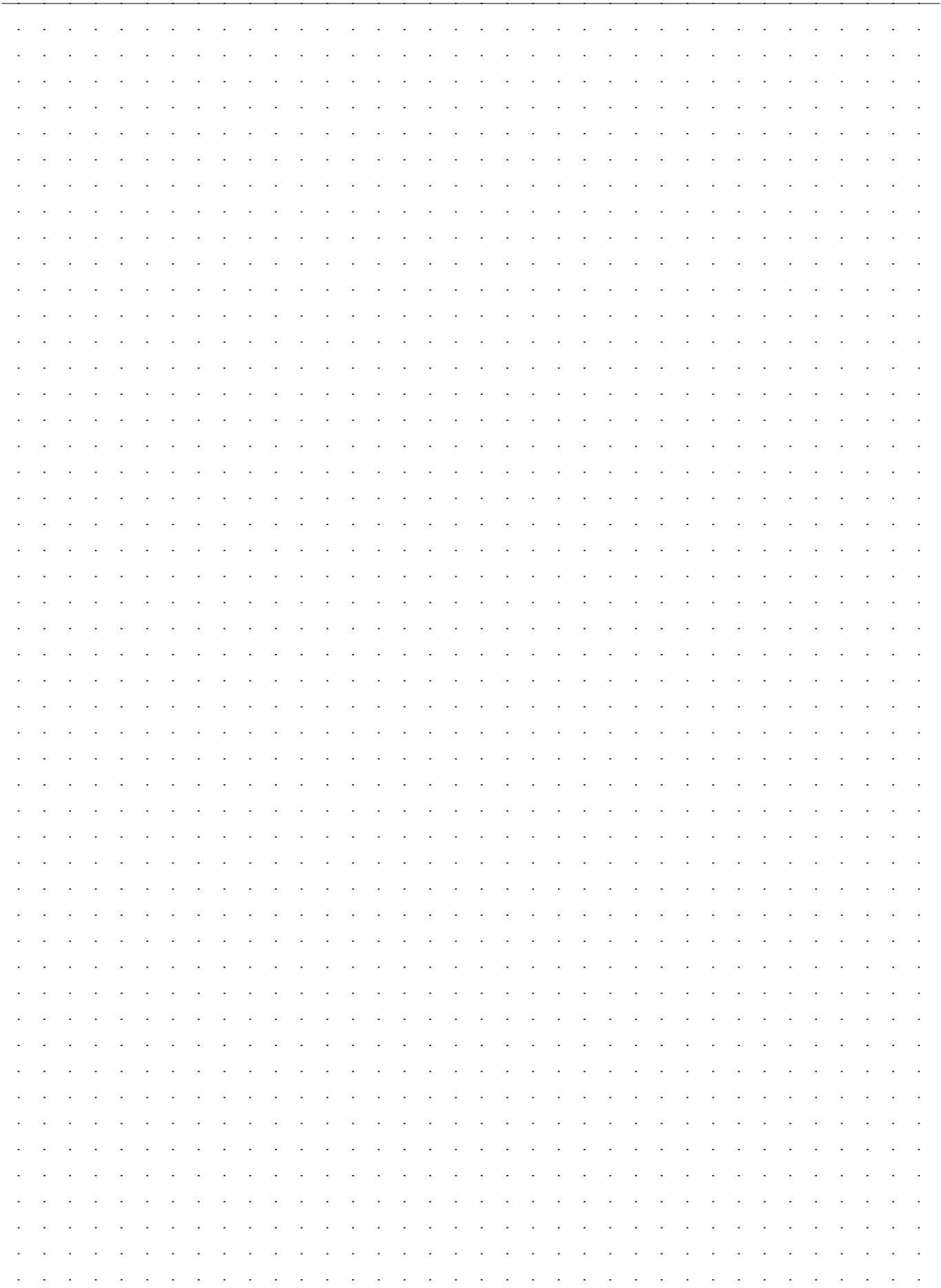

1
2
3
4
5
6
7
8
9
10
11
12
13
14

1	
2	
3	
4	
5	
6	
7	
8	
9	
10	
11	
12	
13	
14	

Europe



Otto Bock HealthCare Deutschland GmbH
Max-Näder-Str. 15 · 37115 Duderstadt · Germany
T +49 5527 848-3411 · F +49 5527 848-1414
healthcare@ottobock.de · www.ottobock.com



Otto Bock Healthcare Products GmbH
Kaiserstraße 39 · 1070 Wien · Austria
T +43 1 5269548 · F +43 1 5267985
vertrieb.austria@ottobock.com · www.ottobock.at



Otto Bock Adria Sarajevo D.O.O.
Omladinskih radnih brigada 5
71000 Sarajevo · Bosnia-Herzegovina
T +387 33 766200 · F +387 33 766201
obadria@bih.net.ba · www.ottobockadria.com.ba



Otto Bock Bulgaria Ltd.
41 Tzar Boris III' Blvd. · 1612 Sofia · Bulgaria
T +359 2 80 57 980 · F +359 2 80 57 982
info@ottobock.bg · www.ottobock.bg



Otto Bock Suisse AG
Pilatestrasse 2 · CH-6036 Dierikon
T +41 41 455 61 71 · F +41 41 455 61 70
suisse@ottobock.com · www.ottobock.ch



Otto Bock ČR s.r.o.
Protetická 460 · 33008 Zruč-Senec · Czech Republic
T +420 377825044 · F +420 377825036
email@ottobock.cz · www.ottobock.cz



Otto Bock Iberica S.A.
C/Majada, 1 · 28760 Tres Cantos (Madrid) · Spain
T +34 91 8063000 · F +34 91 8060415
info@ottobock.es · www.ottobock.es



Otto Bock France SNC
4 rue de la Réunion · CS 90011
91978 Courtaboeuf Cedex · France
T +33 1 69188830 · F +33 1 69071802
information@ottobock.fr · www.ottobock.fr



Otto Bock Healthcare plc
32, Parsonage Road · Englefield Green
Egham, Surrey TW20 0LD · United Kingdom
T +44 1784 744900 · F +44 1784 744901
bockuk@ottobock.com · www.ottobock.co.uk



Otto Bock Hungária Kft.
Tatai út 74. · 1135 Budapest · Hungary
T +36 1 4511020 · F +36 1 4511021
info@ottobock.hu · www.ottobock.hu



Otto Bock Adria d.o.o.
Dr. Franje Tuđmana 14 · 10431 Sveta Nedelja · Croatia
T +385 1 3361 544 · F +385 1 3365 986
ottobockadria@ottobock.hr · www.ottobock.hr



Otto Bock Italia Srl Us
Via Filippo Turati 5/7 · 40054 Budrio (BO) · Italy
T +39 051 692-4711 · F +39 051 692-4710
info.italia@ottobock.com · www.ottobock.it



Otto Bock Benelux B.V.
Ekkersrijt 1412 · 5692 AK
Son en Breugel · The Netherlands
T +31 499 474585 · F +31 499 476250
info.benelux@ottobock.com · www.ottobock.nl



Industria Ortopédica Otto Bock Unip. Lda.
Av. Miguel Bombarda, 21 · 2º Esq.
1050-161 Lisboa · Portugal
T +351 21 3535587 · F +351 21 3535590
ottobockportugal@mail.telepac.pt



Otto Bock Polska Sp. z o. o.
Ulica Koralowa 3 · 61-029 Poznań · Poland
T +48 61 6538250 · F +48 61 6538031
ottobock@ottobock.pl · www.ottobock.pl



Otto Bock Romania srl
Șos de Centura Chitila - Mogoșoia Nr. 3
077405 Chitila, Jud. Ilfov · Romania
T +40 21 4363110 · F +40 21 4363023
info@ottobock.ro · www.ottobock.ro



OOO Otto Bock Service
p/o Pultikovo, Business Park „Greenwood”,
Building 7, 69 km MKAD
143441 Moscow Region/Krasnogorskiy Rayon
Russian Federation
T +7 495 564 8360 · F +7 495 564 8363
info@ottobock.ru · www.ottobock.ru



Otto Bock Scandinavia AB
Koppargatan 3 · Box 623 · 60114 Norrköping · Sweden
T +46 11 280600 · F +46 11 312005
info@ottobock.se · www.ottobock.se



Otto Bock Slovakia s.r.o.
Röntgenova 26 · 851 01 Bratislava 5 · Slovak Republic
T +421 2 32 78 20 70 · F +421 2 32 78 20 89
info@ottobock.sk · www.ottobock.sk



Otto Bock Sava d.o.o.
Maksima Gorkog bb · 18000 Niš · Republika Srbija
T +381 18 4285888 · F +381 18 4539191
info@ottobock.rs · www.ottobock.rs



Otto Bock Ortopedi ve Rehabilitasyon Tekniği Ltd. Şti.
Ali Dursun Bey Caddesi · Latı Lokum Sokak
Meriç Sitesi B Blok No: 6/1
34387 Mecidiyeköy-İstanbul · Turkey
T +90 212 3565040 · F +90 212 3566688
info@ottobock.com.tr · www.ottobock.com.tr

Africa



Otto Bock Algérie E.U.R.L.
32, rue Ahcène Outaleb · Coopérative les Mimosas
Mackle-Ben Aknoun · Alger · DZ Algérie
T +213 21 913863 · F +213 21 913863
information@ottobock.fr · www.ottobock.fr



Otto Bock Egypt S.A.E.
28 Soliman Abaza St. Mohandessein · Giza · Egypt
T +202 330 24 390 · F +202 330 24 380
info@ottobock.com.eg · www.ottobock.com.eg



Otto Bock South Africa (Pty) Ltd
Building 3 Thornhill Office Park · 94 Bekker Road
Midrand · Johannesburg · South Africa
T +27 11 312 1255
info-southafrica@ottobock.co.za · www.ottobock.co.za

Americas



Otto Bock Argentina S.A.
Av. Cabildo 924 · CP 1426
Ciudad Autónoma de Buenos Aires · Argentina
T +54 11 4706-2255 · F +54 11 4788-3006
atencionclientes@ottobock.com.ar
www.ottobock.com.ar



Otto Bock do Brasil Ltda.
Rua Jovelino Aparecido Miguel, 32
13051-030 Campinas-São Paulo · Brasil
T +55 19 3729 3500 · F +55 19 3269 6061
ottobock@ottobock.com.br · www.ottobock.com.br



Otto Bock HealthCare Canada
5470 Harvester Road
Burlington, Ontario, L7L 5N5, Canada
T +1 289 288-4848 · F +1 289 288-4837
infocanada@ottobock.com · www.ottobock.ca



Otto Bock HealthCare Andina Ltda.
Clínica Universitaria Teletón, Autopista Norte km 21
La Caro Chia, Cundinamarca · Bogotá · Colombia
T +57 1 8619988 · F +57 1 8619977
info@ottobock.com.co · www.ottobock.com.co



Otto Bock de Mexico S.A. de C.V.
Prolongación Calle 18 No. 178-A
Col. San Pedro de los Pinos
C.P. 01180 México, D.F. · Mexico
T +52 55 5575 0290 · F +52 55 5575 0234
info@ottobock.com.mx · www.ottobock.com.mx



Otto Bock HealthCare
Two Carlson Parkway North, Suite 100
Minneapolis, MN 55447 · USA
T +1 763 553 9464 · F +1 763 519 6153
usa.customerservice@ottobockus.com · www.ottobockus.com

Asia/Pacific



Otto Bock Australia Pty. Ltd.
Suite 1.01, Century Corporate Centre · 62 Norwest Boulevard
Baulkham Hills NSW 2153 · Australia
T +61 2 8818 2800 · F +61 2 8814 4500
healthcare@ottobock.com.au · www.ottobock.com.au



Beijing Otto Bock Orthopaedic Industries Co., Ltd.
B12E, Universal Business Park
10 Jiuxianqiao Road, Chao Yang District
Beijing, 100015, P.R. China
T +8610 8598 6880 · F +8610 8598 0040
news-service@ottobock.com.cn · www.ottobock.com.cn



Otto Bock Asia Pacific Ltd.
Suite 3218, 32/F., Sun Hung Kai Centre
30 Harbour Road, Wanchai, Hong Kong · China
T +852 2598 9772 · F +852 2598 7886
info@ottobock.com.hk



Otto Bock HealthCare India
Behind FairLawn Housing Society
St. Gregorios Lane, Sion Trombay Road
Chembur, Mumbai, 400071 · India
T +91 22 2520 1268 · F +91 22 2520 1267
information@indiaottobock.com · www.ottobock.in



Otto Bock Japan K. K.
Yokogawa Building 8F, 4-4-44 Shibaura
Minato-ku, Tokyo, 108-0023 · Japan
T +81 3 3798-2111 · Fax +81 3 3798-2112
ottobock@ottobock.co.jp · www.ottobock.co.jp



Otto Bock Korea HealthCare Inc.
4F Agaworld Building · 1357-74, Seocho-dong
Seocho-ku, 137-070 Seoul · Korea
T +82 2 577-3831 · F +82 2 577-3828
info@ottobockkorea.com · www.ottobockkorea.com



Otto Bock South East Asia Co., Ltd.
1741 Phaholyothin Road,
Kwaeng Chatuchark, Khet Chatuchark
Bangkok 10900 · Thailand
T +66 2 930 3030 · F +66 2 930 3311
obsea@ottobock.co.th · www.ottobock.co.th

