



# Genium X3 3B5-3/3B5-3=ST

EN Instructions for use (qualified personnel) ..... 7

# Quick Reference Guide



This "Quick Reference Guide" does not replace the instructions for use

## 6

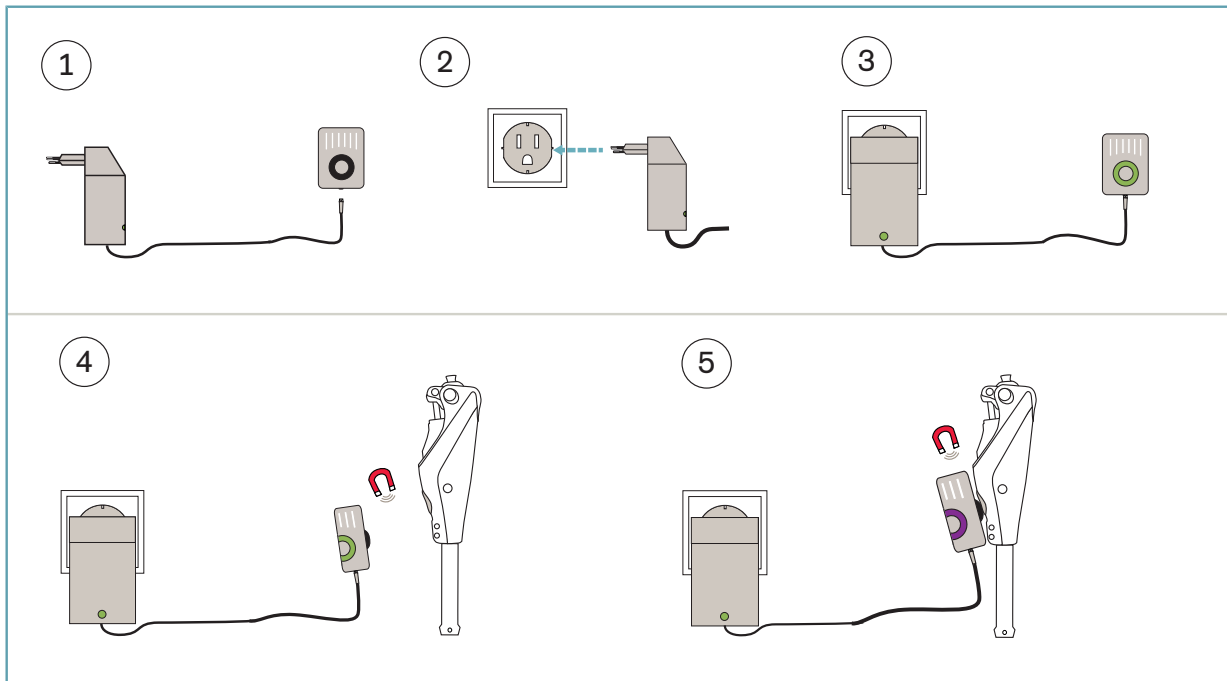

## 7.1.2

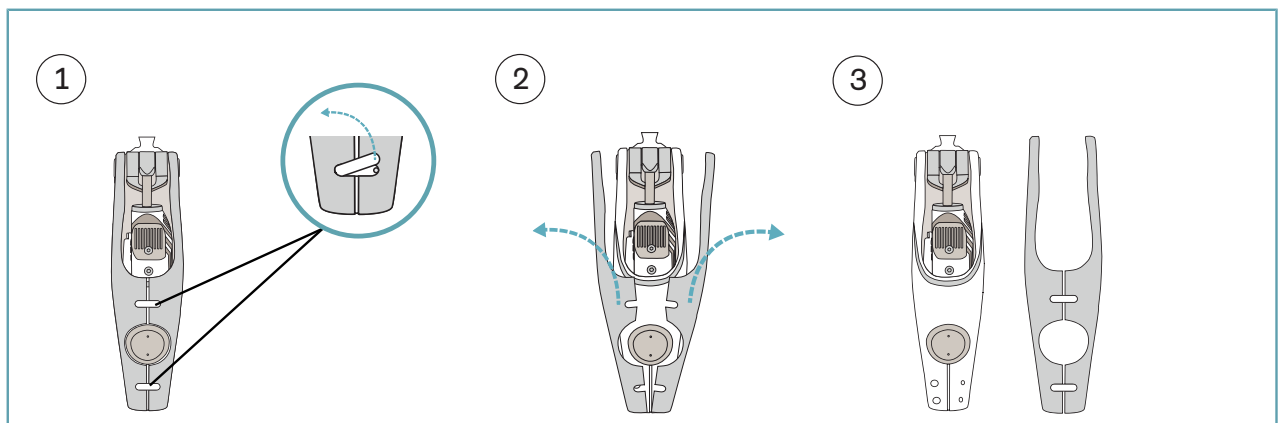

### 7.1.3

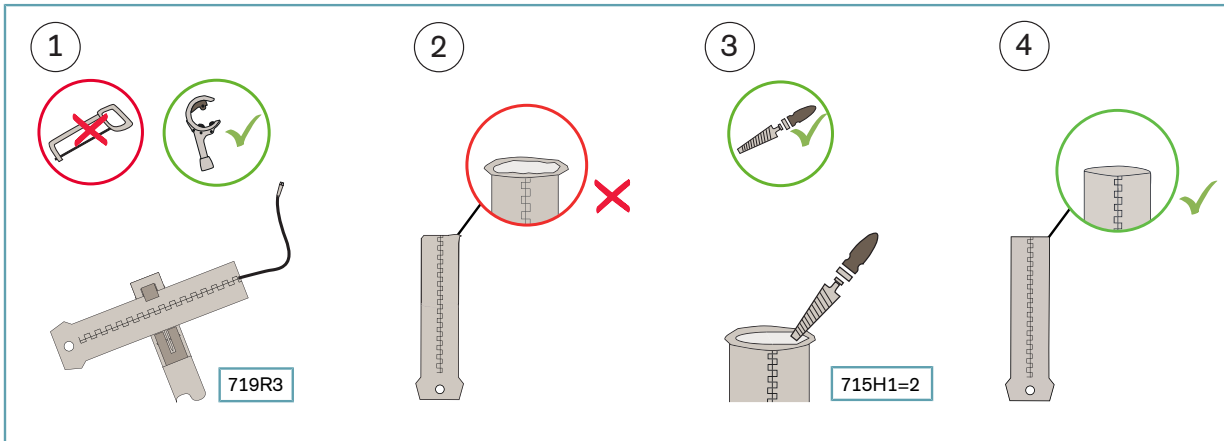

### 7.1.4

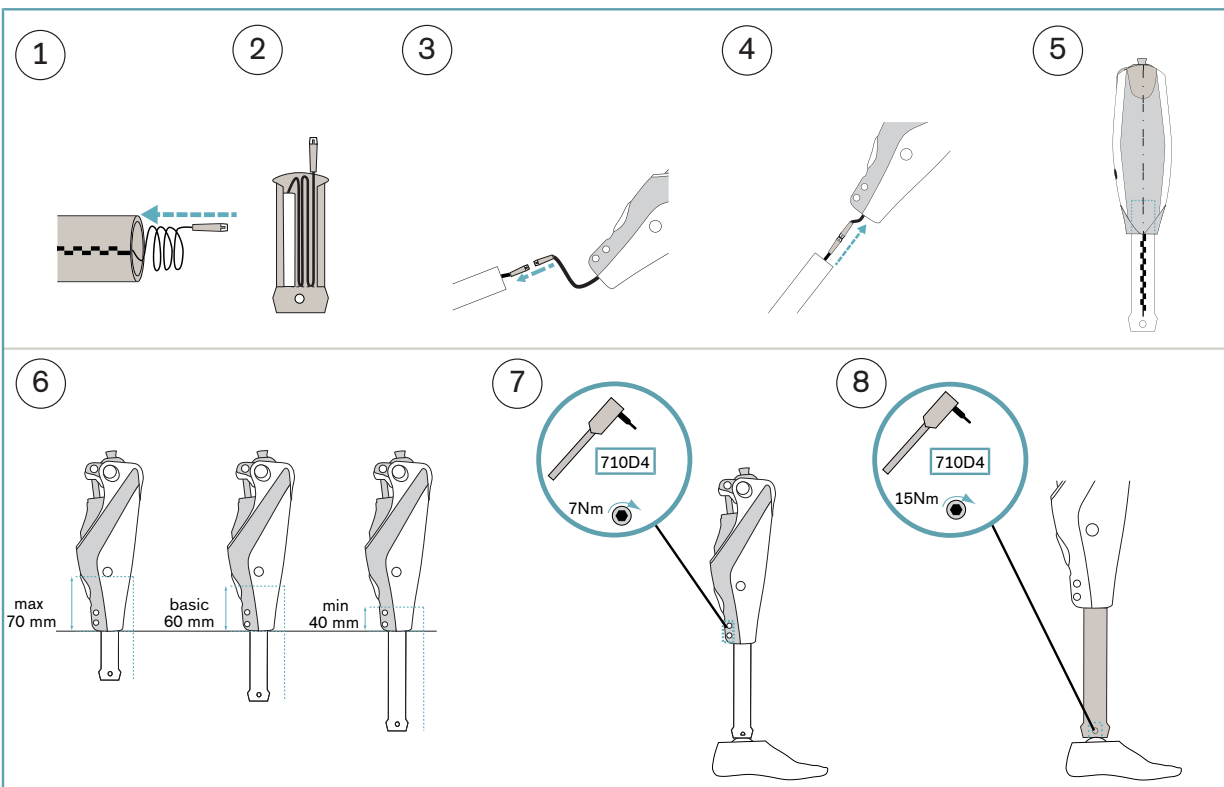

 7.1.8

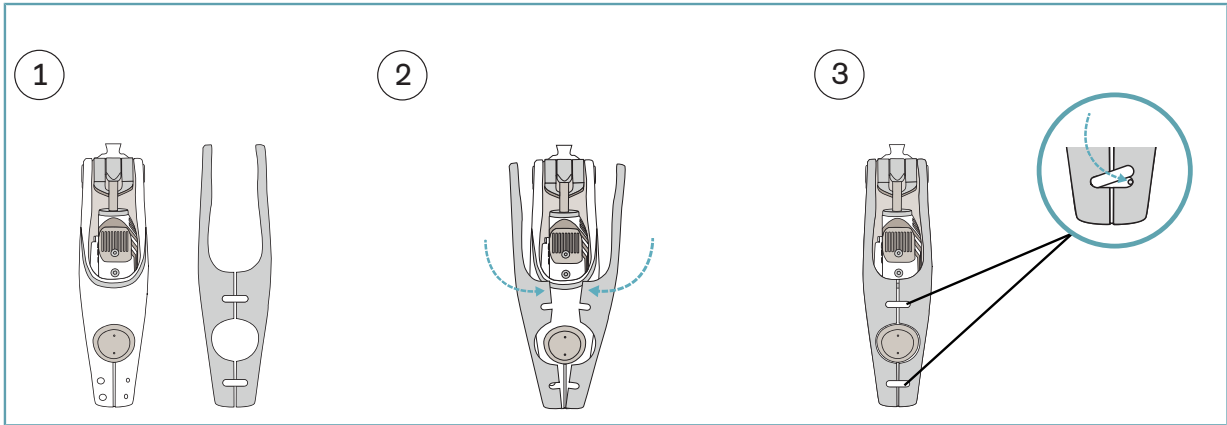

 7.1.9

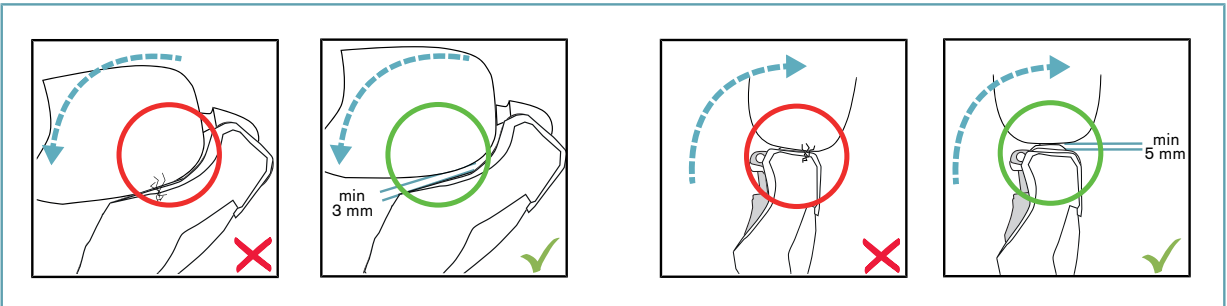

 7.1.6

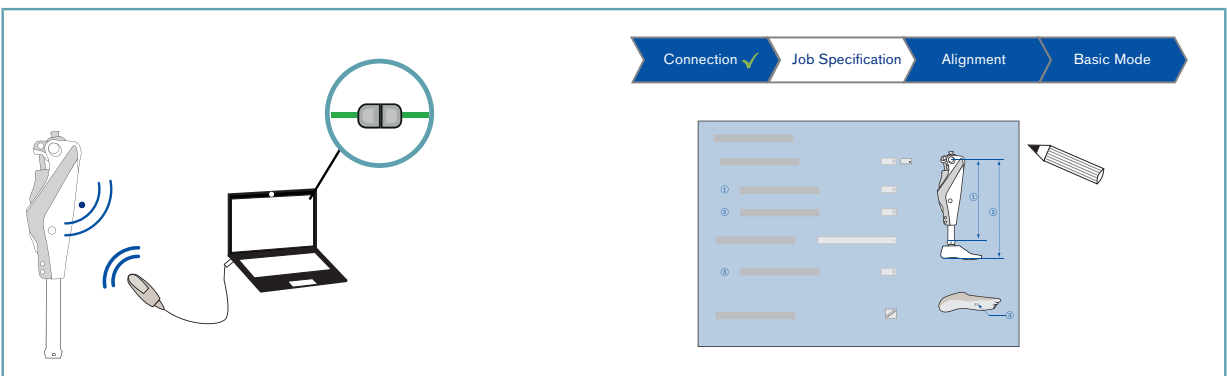

## 7.1.6

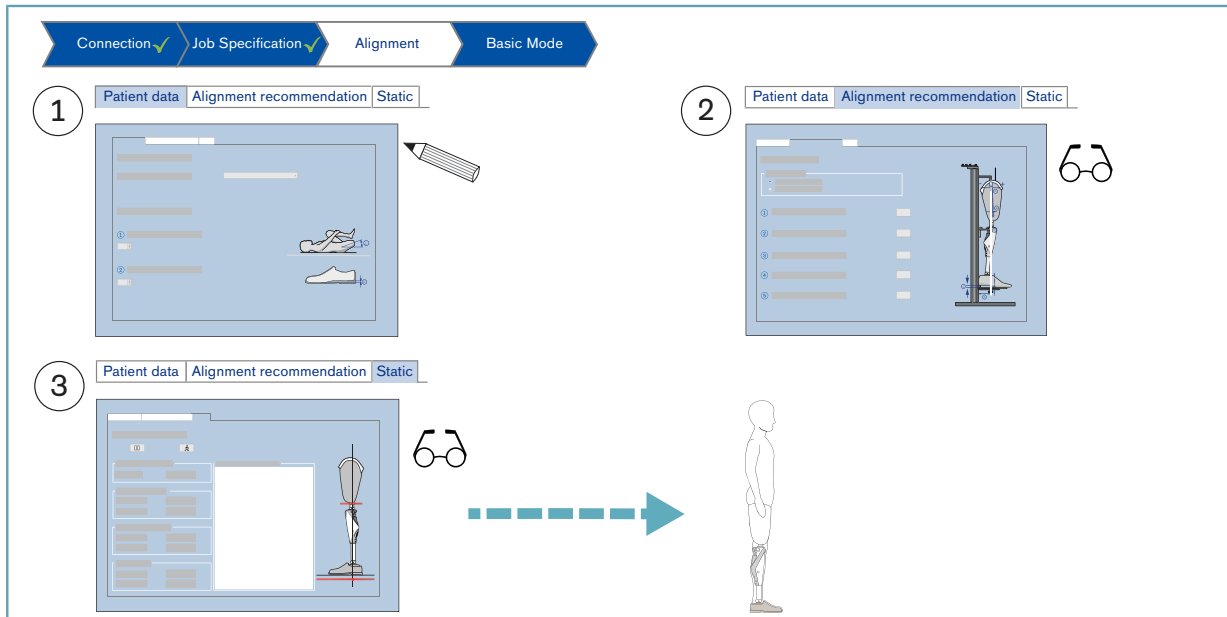

## 7.1.7

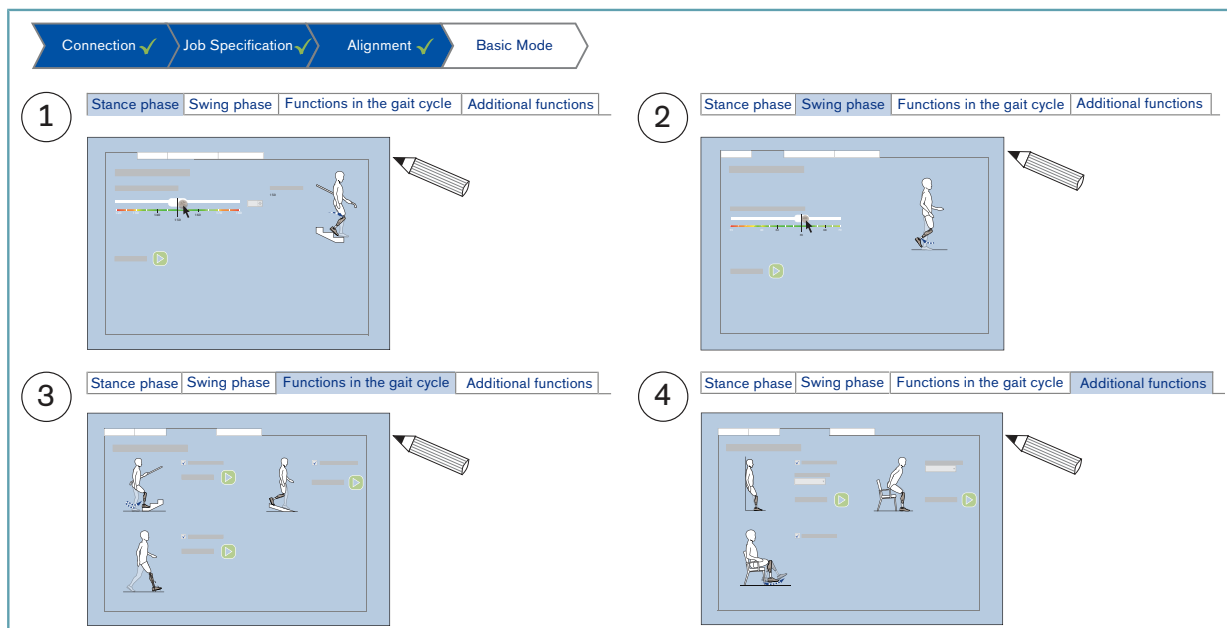

## 7.1.9

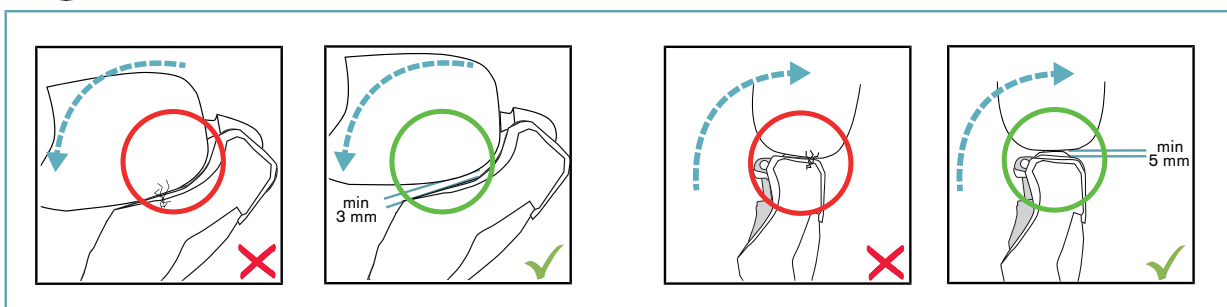

---

## Symbols Used



Read the section in the instructions for use



Magnetic components

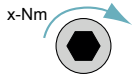

Tightening torque in the direction of rotation and screw geometry



Use a torque wrench



Wrong



Right



Use the adjustment software



A successful connection between the product and the adjustment software is established



Fill in the fields in the adjustment software



Check the values

# Table of contents

EN

<b>1</b>	<b>Foreword</b> .....	<b>10</b>
<b>2</b>	<b>Product description</b> .....	<b>10</b>
2.1	Design .....	10
2.2	Function .....	10
2.3	Combination possibilities .....	11
2.3.1	Limits for combination options with prosthetic feet .....	12
2.3.2	Combination with an osseointegrated implant system .....	12
<b>3</b>	<b>Application</b> .....	<b>13</b>
3.1	Indications for use.....	13
3.2	Conditions of use.....	13
3.3	Indications .....	13
3.4	Contraindications.....	13
3.4.1	Absolute Contraindications .....	13
3.5	Qualification .....	13
<b>4</b>	<b>Safety</b> .....	<b>14</b>
4.1	Explanation of warning symbols .....	14
4.2	Structure of the safety instructions .....	14
4.3	General safety instructions .....	14
4.4	Information on the Power Supply/Battery Charging .....	16
4.5	Battery charger information .....	17
4.6	Information on Alignment/Adjustment .....	18
4.7	Information on Proximity to Certain Areas.....	19
4.8	Information on Use .....	20
4.9	Notes on the safety modes .....	22
4.10	Instructions for use with an osseointegrated implant system .....	22
4.11	Information on the use of a mobile device with the cockpit app .....	23
<b>5</b>	<b>Scope of Delivery and Accessories</b> .....	<b>23</b>
5.1	Scope of delivery .....	23
5.2	Accessories .....	24
<b>6</b>	<b>Charging the battery</b> .....	<b>24</b>
6.1	Connecting the power supply and battery charger .....	24
6.2	Charging the prosthesis battery .....	24
6.3	Display of the current charge level.....	25
6.3.1	Display of battery charge level without additional devices .....	25
6.3.2	Display of the current charge level using the Cockpit app .....	25
6.3.3	Display of the current charge level during the charging process.....	26
<b>7</b>	<b>Preparing the product for use</b> .....	<b>26</b>
7.1	Alignment.....	26
7.1.1	Settings with the "X-Soft" adjustment software .....	26
7.1.1.1	Introduction.....	26
7.1.1.2	Data transfer between the product and the PC .....	27
7.1.1.3	Preparing the product to connect to the adjustment software .....	27
7.1.2	Removing the Protective Cover .....	27
7.1.3	Shortening the Tube Adapter .....	27
7.1.4	Installing the Tube Adapter.....	28
7.1.5	Bench alignment in alignment apparatus.....	28
7.1.6	Static alignment optimisation .....	28
7.1.7	Dynamic alignment optimisation .....	29
7.1.8	Protective Cover Installation .....	29
7.1.9	Checking the socket after bench alignment .....	29
7.1.10	Flexion stop.....	30
<b>8</b>	<b>Cockpit app</b> .....	<b>30</b>
8.1	System Requirements.....	31

8.2	Initial connection between cockpit app and prosthesis.....	31
8.2.1	Starting the cockpit app for the first time .....	31
8.3	Control elements for cockpit app .....	32
8.3.1	Cockpit app navigation menu .....	32
8.4	Managing components .....	33
8.4.1	Adding component.....	33
8.4.2	Deleting a component.....	33
8.4.3	Connecting component with multiple mobile devices .....	33
<b>9</b>	<b>Use.....</b>	<b>34</b>
9.1	Movement patterns in basic mode (mode 1) .....	34
9.1.1	Standing .....	34
9.1.1.1	Stance function.....	34
9.1.2	Walking .....	35
9.1.3	Running short distances ("walk-to-run" function).....	35
9.1.4	Sitting down .....	35
9.1.5	Sitting.....	35
9.1.5.1	Sitting function .....	35
9.1.6	Standing up .....	36
9.1.7	Walking up stairs step-over-step .....	36
9.1.8	Overcoming obstacles .....	36
9.1.9	Walking down stairs .....	37
9.1.10	Walking down a ramp.....	37
9.1.11	Configuration for walking down stairs/ramp using the adjustment software .....	37
9.2	Changing prosthesis settings .....	37
9.2.1	Changing the prosthesis setting using the cockpit app .....	38
9.2.1.1	Overview of adjustment parameters in basic mode .....	38
9.2.1.2	Overview of adjustment parameters in MyModes.....	39
9.3	Turning Bluetooth on the prosthesis on/off .....	40
9.3.1	Switching Bluetooth off/on using the cockpit app.....	40
9.4	Querying the prosthesis status.....	40
9.4.1	Query status through cockpit app .....	40
9.4.2	Status display in the cockpit app.....	40
9.5	Mute mode (silent mode) .....	41
9.5.1	Turning mute mode on/off using the Cockpit app .....	41
9.6	Deep sleep mode .....	41
9.6.1	Turning deep sleep mode on/off using the Cockpit app .....	41
9.7	OPG function (Optimised Physiological Gait) .....	41
<b>10</b>	<b>MyModes.....</b>	<b>42</b>
10.1	Running function as configured MyMode .....	42
10.2	Switching MyModes with the cockpit app .....	43
10.3	Switching MyModes using motion patterns .....	43
10.4	Switching from a MyMode back to basic mode .....	44
<b>11</b>	<b>Additional operating states (modes).....</b>	<b>45</b>
11.1	Empty battery mode.....	45
11.2	Mode for charging the prosthesis.....	45
11.3	Safety mode .....	45
11.4	Overheating mode.....	45
<b>12</b>	<b>Storage and bleeding .....</b>	<b>46</b>
<b>13</b>	<b>Cleaning .....</b>	<b>46</b>
<b>14</b>	<b>Maintenance .....</b>	<b>46</b>
14.1	Identification of the product by the Service Center .....	46
<b>15</b>	<b>Legal information.....</b>	<b>46</b>
15.1	Liability .....	47
15.2	Trademarks .....	47
15.3	CE conformity.....	47
15.4	Local Legal Information .....	47



---

<b>16</b>	<b>Technical data .....</b>	<b>48</b>
<b>17</b>	<b>Appendices .....</b>	<b>50</b>
17.1	Symbols Used .....	50
17.2	Operating states/error signals .....	51
17.2.1	Signals for operating states .....	51
17.2.2	Warnings/error signals .....	52
17.2.3	Error messages while establishing a connection with the cockpit app .....	54
17.2.4	Status signals .....	54
17.3	Directives and manufacturer's declaration .....	55
17.3.1	Electromagnetic environment .....	55

# 1 Foreword

## INFORMATION

Date of last update: 2022-02-22

- ▶ Please read this document carefully before using the product and observe the safety notices.
- ▶ Instruct the user in the safe use of the product.
- ▶ Please contact the manufacturer if you have questions about the product or in case of problems.
- ▶ Report each serious incident related to the product to the manufacturer and to the relevant authority in your country. This is particularly important when there is a decline in the health state.
- ▶ Please keep this document for your records.

The product "3B5-3, 3B5-3=ST Genium" is called the product/prosthesis/knee joint/component in the following. These instructions for use provide you with important information on the use, adaptation and handling of the product.

Only put the product into use in accordance with the information contained in the accompanying documents supplied.

According to the manufacturer (Otto Bock Healthcare Products GmbH), the patient is the operator of the product according to the IEC 60601-1:2005/A1:2012 standard.

## 2 Product description

### 2.1 Design

The product consists of the following components:



1. Proximal pyramid adapter
2. Optional flexion stops
3. Battery
4. Hydraulic unit
5. LED (blue) as indicator for the Bluetooth connection
6. Receiver of the inductive charging unit
7. Distal tube clamp screws (covered by protector)
8. Connecting cable for tube adapter

### 2.2 Function

This product features microprocessor control of the stance and swing phase.

The microprocessor uses the measurements of an integrated sensor system as a basis to control a hydraulic unit that influences the damping behaviour of the product.

These sensor data are updated and evaluated 100 times per second. As a result, the behaviour of the product is adapted to the current motion situation (gait phase) dynamically and in real time.

The product can be individually adapted to the needs of the patient with the X-soft adjustment software.

The product features MyModes for special motion types (e.g. cycling ...). These are pre-configured using the adjustment software and can be activated with special movement patterns and the Cockpit app (see page 42).

In case of a product malfunction, safety mode makes restricted operation possible. Resistance parameters that are predefined by the product are configured for this purpose (see page 45).

Empty battery mode permits safe walking when the battery is drained. Resistance parameters that are predefined by the product are configured for this purpose (see page 45).

**The microprocessor-controlled hydraulic unit offers the following advantages**

- Approximation of the physiological gait pattern
- Stability while standing and walking
- Adaptation of product characteristics to various surfaces, inclines, gait situations and walking speeds

**Essential performance of the product**

- Stability in the stance phase
- Adjustable swing phase extension resistance

**2.3 Combination possibilities**

This product can be combined with the following Ottobock components:

**Prosthetic hip joints**

- Modular prosthetic hip joint: 7E7
- Monocentric prosthetic hip joint: 7E9
- Helix <sup>3D</sup> prosthetic hip joint: 7E10

**Adapters**

- 4R104=60 double adapter, sliding
- 4R104=75 double adapter, sliding
- Rotation adapter: 4R57, 4R57=\*
- 4R41 lamination anchor with pyramid receiver
- 4R43 lamination anchor with threaded connector
- 4R89 lamination anchor with pyramid adapter
- 4R111=N lamination anchor with threaded connector
- 4R111 lamination anchor with pyramid receiver
- 4R116 lamination anchor with pyramid adapter
- Lamination anchor with pyramid receiver and angled arm: 4R119
- 4R40 torsion adapter
- 4R118 adapter plate
- Quickchange: 4R10

**Tube adapter**

- AXON tube adapter: 2R19

**Cosmetic cover/protector**

- Genium X3 Protective Cover: 4X900
- Genium X3 Protective Cover: 4X193-1

**Prosthetic feet**

The maximum allowable patient weight depends on the foot size.

- 1C30 Trias
- 1C30-1 Trias
- 1D35 Dynamic Motion
- 1C40 C-Walk
- Taleo: 1C50
- 1C51 Taleo Vertical Shock:
- Taleo Harmony: 1C52
- Taleo Low Profile: 1C53
- 1C58 Taleo Side Flex
- 1C60 Triton
- 1C61 Triton Vertical Shock
- 1C62 Triton Harmony
- 1C63 Triton Low Profile
- 1C64 Triton Heavy Duty
- RS2-00 Runway<sup>1</sup>, RS2-K1 Runway HX<sup>1</sup>
- Triton side flex: 1C68
- 1E56 Axtion
- 1E57 Lo Rider
- Challenger: 1E95
- 1B1 Meridium
- 1B1-2 Meridium
- 1C10 Terion
- 1A1-2 Empower
- F21 Maverick Xtreme AT<sup>1</sup>
- F22 Maverick Comfort AT<sup>1</sup>
- F11 Maverick Xtreme<sup>1</sup>
- FS5 Thrive<sup>1</sup>
- LP-W2 Freestyle Swim<sup>1</sup>

<sup>1</sup> Note the Ottobock system height

**INFORMATION**

**Calculating the Ottobock system height for the F11, F21, F22, FS5, LP2-W2, RS2-00, RS2-K1 prosthetic feet**

To calculate the Ottobock system height (e.g. for input in the adjustment software), the build height according to the technical data for the listed prosthetic feet has to be reduced by about 18 mm.

Example: The build height of the "F22" prosthetic foot in size 26 is 117 mm.

Therefore, the system height is: 117 mm – 18 mm = 99 mm. This is only a reference value. Therefore, measure and verify the distances on the patient before shortening the tube adapter.

**2.3.1 Limits for combination options with prosthetic feet**

**CAUTION**

**Failure to observe the tables provided**

Falling due to breakage of load-bearing components of the knee joint.

- ▶ Depending on the patient’s body weight, the listed prosthetic feet may only be combined in the respective foot sizes [cm] described.
- ▶ Inform the patient that the body weights changes when carrying heavy objects, backpacks or children.
- ▶ Please contact Ottobock customer service if you would like a combination outside the approved ranges.

**1C63 Triton Low Profile**

Body weight	Approved foot size [cm]
Up to 125 kg (up to 275 lbs)	21 to 30
126 kg to 150 kg (276 lbs to 330 lbs)	21 to 28

**Maverik Xtreme AT F21**

Body weight	Approved foot size [cm]	Maximum stiffness
Up to 125 kg (275 lbs)	Up to 30	9
126 kg to 150 kg (277 lbs to 330 lbs)	Up to 27	9
	Up to 28	7

**Thrive FS5**

Body weight	Approved foot size [cm]	Maximum stiffness
Up to 125 kg (275 lbs)	Up to 31	9
126 kg to 150 kg (277 lbs to 330 lbs)	Up to 26	9

**Freestyle Swim LP2-W2**

Body weight	Approved foot size [cm]	Maximum stiffness
Up to 100 kg (220 lbs)	Up to 31	6
101 kg to 150 kg (222 lbs to 330 lbs)	Not approved	

**2.3.2 Combination with an osseointegrated implant system**

This product can be connected to a socket or to an osseointegrated, percutaneous implant system.

In case of connection to an implant system, verify that the manufacturer of the implant system and the manufacturers of the corresponding exoprosthetic components/adapters also permit this combination. It must be ensured that all indications/contraindications, the field of application, the conditions of use and all safety instructions are complied with for the implant system, corresponding exoprosthetic components, corresponding adapters and for the knee joint.

Among other things, this relates to the body weight, mobility grade, type of activity, load capacity of the implant and bone anchoring, freedom from pain under functional load and compliance with the permissible ambient conditions (see page 48).

Please ensure that the qualified personnel applying the product is not only authorised for fitting this knee joint, but also for the connection to the osseointegrated implant system.

## 3 Application

### 3.1 Indications for use

The product is to be used **solely** for lower limb exoprosthesis fittings.

### 3.2 Conditions of use

The product was developed for everyday use and must not be used for unusual activities. These unusual activities include, for example, extreme sports (free climbing, parachuting, paragliding, etc.).

Permissible ambient conditions are described in the technical data (see page 48).

The product is intended **exclusively** for use on **one** patient. Use of the product by another person is not approved by the manufacturer.

Our components perform optimally when paired with appropriate components based upon weight and mobility grades identifiable by our MOBIS classification information and which have appropriate modular connectors.

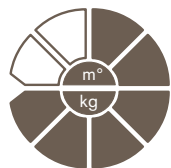

The product is recommended for mobility grade 3 (unrestricted outdoor walker) and mobility grade 4 (unrestricted outdoor walker with particularly high demands). Approved for a max. body weight of **150 kg (330 lbs)**.

### 3.3 Indications

- For patients with knee disarticulation, transfemoral amputation or hip disarticulation
- For unilateral or bilateral amputation
- Dysmelia patients with residual limb characteristics corresponding to knee disarticulation, transfemoral amputation or hip disarticulation
- The patient must fulfil the physical and mental requirements for perceiving visual/acoustic signals and/or mechanical vibrations.

### 3.4 Contraindications

#### 3.4.1 Absolute Contraindications

- Body weight over 150 kg



### 3.5 Qualification

The product may be fitted only by qualified personnel authorised by Ottobock after completing the corresponding training.

If the product is to be connected to an osseointegrated implant system, the qualified personnel must also be authorised for the connection to the osseointegrated implant system.

## 4 Safety

### 4.1 Explanation of warning symbols

 <b>WARNING</b>	Warning regarding possible serious risks of accident or injury.
 <b>CAUTION</b>	Warning regarding possible risks of accident or injury.
 <b>NOTICE</b>	Warning regarding possible technical damage.

### 4.2 Structure of the safety instructions

<p> <b>CAUTION</b></p> <p><b>The heading describes the source and/or the type of hazard</b></p> <p>The introduction describes the consequences in case of failure to observe the safety instructions. Consequences are presented as follows if more than one consequence is possible:</p> <ul style="list-style-type: none"> <li>&gt; E.g.: Consequence 1 in case of failure to observe the hazard</li> <li>&gt; E.g.: Consequence 2 in case of failure to observe the hazard</li> <li>▶ This symbol identifies activities/actions that must be observed/carried out in order to avert the hazard.</li> </ul>
--

### 4.3 General safety instructions

<p> <b>WARNING</b></p> <p><b>Non-observance of safety notices</b></p> <p>Personal injury/damage to the product due to using the product in certain situations.</p> <ul style="list-style-type: none"> <li>▶ Observe the safety notices and the stated precautions in this accompanying document.</li> </ul>
--

<p> <b>WARNING</b></p> <p><b>Use of damaged power supply unit, adapter plug or battery charger</b></p> <p>Risk of electric shock due to contact with exposed, live components.</p> <ul style="list-style-type: none"> <li>▶ Do not open the power supply unit, adapter plug or battery charger.</li> <li>▶ Do not expose the power supply unit, adapter plug or battery charger to extreme loading conditions.</li> <li>▶ Immediately replace damaged power supply units, adapter plugs or battery chargers.</li> </ul>
---

<p> <b>CAUTION</b></p> <p><b>Failure to observe warning/error signals</b></p> <p>Falling due to unexpected product behaviour because of changed damping behaviour.</p> <ul style="list-style-type: none"> <li>▶ The warnings/error signals (see page 52) and corresponding change in damping settings must be observed.</li> </ul>
---

<p> <b>CAUTION</b></p> <p><b>Failure to observe activated mute mode (silent mode)</b></p> <p>Falling due to unexpected product behaviour because of changed damping behaviour.</p> <p>The following feedback signals are deactivated when mute mode is activated:</p> <ul style="list-style-type: none"> <li>&gt; Long vibration signal if the hydraulic unit overheats.</li> <li>&gt; Beep and vibration signal to confirm that the movement pattern has been recognised (switching to a MyMode/basic mode with movement pattern).</li> <li>&gt; Beep and vibration signal to indicate successful switching to a MyMode/basic mode.</li> <li>&gt; Beep and vibration signal upon successfully switching to deep sleep mode.</li> <li>▶ Before activating mute mode, note that these feedback signals will be deactivated. For more information about mute mode, see the section "Mute mode" (see page 41).</li> <li>▶ Inform the patient that the changed damping characteristics have to be verified after switching to a MyMode/basic mode.</li> <li>▶ Ensure that the patient stands securely during all switching processes.</li> <li>▶ To deactivate mute mode, connect and then disconnect the battery charger.</li> </ul>
--

**⚠ CAUTION****Independent manipulation of the product and the components**

Falling due to breakage of load-bearing components or malfunction of the product.

- ▶ Manipulations to the product other than the tasks described in these instructions for use are not permitted.
- ▶ The battery may only be handled by authorised, qualified Ottobock personnel (no replacement by the user).
- ▶ The product and any damaged components may only be opened and repaired by authorised, qualified Ottobock personnel.

**⚠ CAUTION****Mechanical stress on the product**

- > Falling due to unexpected product behaviour as the result of a malfunction.
- > Falling due to breakage of load-bearing components.
- > Skin irritation due to defects on the hydraulic unit with leakage of liquid.
- ▶ Do not subject the product to mechanical vibrations or impacts.
- ▶ Check the product for visible damage before each use.

**⚠ CAUTION****Use of the product when battery charge level is too low**

Falling due to unexpected behaviour of the prosthesis because of changed damping behaviour.

- ▶ Check the current charge level before use and charge the prosthesis if required.
- ▶ Note that the operating time of the product may be reduced at low ambient temperatures or due to ageing of the battery.

**⚠ CAUTION****Risk of pinching in the joint flexion area**

Injuries due to pinching of body parts.

- ▶ Ensure that fingers/body parts or soft tissue of the residual limb are not in this area when bending the joint.

**⚠ CAUTION****Penetration of dirt and humidity into the product**

- > Falling due to unexpected product behaviour as the result of a malfunction.
- > Falling due to breakage of load-bearing components.
- ▶ Ensure that no solid particles or foreign objects can penetrate into the product.
- ▶ The knee joint and the AXON tube adapter are waterproof, corrosion-resistant and protected against the penetration of jets of water. The knee joint and AXON tube adapter can be operated in fresh and salt water. Do not use the knee joint under extreme conditions like diving or jumping into water. The knee joint and AXON tube adapter are designed for underwater use (for the maximum duration and water depth, see the section "Technical data" (see page 48).
- ▶ After contact with water, hold the prosthesis with the sole of the foot facing up until the water has drained from the knee joint and AXON tube adapter.
- ▶ After using the knee joint in a salt water environment, remove the Protective Cover and rinse knee joint, AXON tube adapter and Protective Cover with fresh water. Dry the knee joint and components with a lint-free cloth and allow the components to fully air dry.
- ▶ Should the knee joint or AXON tube adapter come into contact with **solutions other than fresh or salt water, promptly** remove the Protective Cover and clean the **knee joint**. In order to do so, rinse knee joint, AXON tube adapter and Protective Cover with fresh water and let them dry.
- ▶ In case of a malfunction after drying, the knee joint and AXON tube adapter must be inspected by an authorised Ottobock Service Center.
- ▶ The knee joint and the AXON tube adapter are not protected against the penetration of steam.

**⚠ CAUTION**

**Use of the product without protector or with damaged protector**

- > Falling due to unexpected product behaviour as the result of malfunction.
- > Falling due to breakage of load-bearing components.
- ▶ If the protector has been removed, ensure prior to the next use of the product that the protector has been properly installed.
- ▶ Using the product with a damaged protector or without the protector is not permitted.
- ▶ Using the product with a foam cover is not possible, since the protector would have to be removed for this purpose.

**⚠ CAUTION**

**Mechanical stress during transport**

- > Falling due to unexpected product behaviour as a result of a malfunction.
- > Falling due to breakage of load-bearing components.
- > Skin irritation due to defects on the hydraulic unit with leakage of liquid.
- ▶ Only use the transport packaging for transportation.

**⚠ CAUTION**

**Signs of wear and tear on the product components**

Falling due to damage or malfunction of the product.

- ▶ Regular service inspections (maintenance) are mandatory in the interest of patient safety and in order to maintain operating reliability and protect the warranty.

**⚠ CAUTION**

**Use of unapproved accessories**

- > Falling due to product malfunction as a result of reduced interference resistance.
- > Interference of other electronic devices due to increased emissions.
- ▶ Use the product only in combination with the accessories, signal converters and cables listed in the sections "Scope of delivery" (see page 23) and "Accessories" (see page 24).

**NOTICE**

**Improper product care**

Damage to the product due to the use of incorrect cleaning agents.

- ▶ Clean the product with a damp cloth only (fresh water).
- ▶ Only use fresh water with a temperature of no more than 65°C for cleaning.
- ▶ If dirt cannot be removed, the product has to be sent to an authorised Ottobock Service Centre.

**INFORMATION**

**Knee joint movement noise**

When using exoprosthetic knee joints, servomotor, hydraulic, pneumatic or brake load dependent control functions can cause movement noise. This kind of noise is normal and unavoidable. It generally does not indicate any problems. If movement noise increases noticeably during the lifecycle of the knee joint, the knee joint should be inspected by an authorised Ottobock Service Centre immediately.

**4.4 Information on the Power Supply/Battery Charging**

**⚠ CAUTION**

**Charging the product without taking it off**

Falling due to unexpected product behaviour because of changed damping behaviour.

- ▶ Instruct the patient that the product must be taken off before it is charged.



**⚠ CAUTION****Charging the product with damaged power supply unit/charger/charger cable**

Falling due to unexpected behaviour of the product caused by insufficient charging.

- ▶ Check the power supply unit, charger and charger cable for damage before use.
- ▶ Replace any damaged power supply unit, charger or charger cable.

**NOTICE****Use of incorrect power supply unit/battery charger**

Damage to product due to incorrect voltage, current or polarity.

- ▶ Use only power supply units/battery chargers approved for this product by Ottobock (see instructions for use and catalogues).

**4.5 Battery charger information****⚠ WARNING****Storing/transporting the product near active implanted systems**

Interference with active implantable systems (e.g. pacemaker, defibrillator, etc.) due to the product's magnetic field.

- ▶ When storing/transporting the product in the immediate vicinity of active implantable systems, ensure that the minimum distances stipulated by the manufacturer of the implant are observed.
- ▶ Make sure to observe any operating conditions and safety notices stipulated by the manufacturer of the implant.

**NOTICE****Penetration of dirt and humidity into the product**

Lack of proper charging functionality due to malfunction.

- ▶ Ensure that neither solid particles nor liquids can penetrate into the product.

**NOTICE****Mechanical stress on the power supply/battery charger**

Lack of proper charging functionality due to malfunction.

- ▶ Do not subject the power supply/battery charger to mechanical vibrations or impacts.
- ▶ Check the power supply/battery charger for visible damage before each use.

**NOTICE****Operating the power supply unit/charger outside of the permissible temperature range**

Lack of proper charging functionality due to malfunction.

- ▶ Only use the power supply unit/charger for charging within the allowable temperature range. The section "Technical data" contains information on the allowable temperature range (see page 48).

**NOTICE****Independent changes or modifications carried out to the battery charger**

Lack of proper charging functionality due to malfunction.

- ▶ Have any changes or modifications carried out only by Ottobock authorised, qualified personnel.

**NOTICE****Contact of the battery charger with magnetic data storage devices**

Wiping of the data storage device.

- ▶ Do not place the battery charger on credit cards, diskettes, audio or video cassettes.

**NOTICE****Improper care of the housing**

Damage to the casing through the use of acetone, white spirit or similar solvents.

- ▶ Only clean the housing with a damp cloth and mild soap (e.g. 453H10=1 Ottobock DermaClean).

## 4.6 Information on Alignment/Adjustment

**⚠ CAUTION**

**Use of unsuitable prosthetic components**

Falling due to unexpected behaviour of the product or breakage of load-bearing components.

- ▶ Use the product only in combination with the components listed in the section "Combination possibilities" (see page 11).
- ▶ If the product is to be used in water, salt water or chlorinated water, the entire prosthesis has to be suitable for such use. Resistance to these liquids has to be checked for each prosthetic component.

**⚠ CAUTION**

**Improper assembly of the screw connections**

Falling due to breakage or loosening of the screw connections.

- ▶ Clean the threads before every installation.
- ▶ Apply the specified tightening torque values for installation (see the section "Technical data").
- ▶ Observe the instructions for securing the screw connections and the use of the correct length.

**⚠ CAUTION**

**Incorrectly secured screws**

Falling due to breakage of load-bearing components caused by screw connections coming loose.

- ▶ After completing all settings, the set screws in the tube adapter must be secured before they are tightened to the specified torque (see the section "Technical data" see page 48).
- ▶ The tube clamp screws must not be secured but only tightened to the specified torque.

**⚠ CAUTION**

**Incorrect alignment or assembly**

Falling due to damage to the prosthesis components.

- ▶ Observe the alignment and assembly instructions.

**⚠ CAUTION**

**Errors during prosthesis alignment**

- > Falling due to unexpected product behaviour as the result of a malfunction.
- > Falling due to breakage of load-bearing components.
- ▶ At maximum flexion, it is essential to maintain a minimum distance of 3 mm (1/8") between the hydraulic unit and the socket.
- ▶ At maximum extension (reached under full load), it is essential to maintain a minimum distance of 5 mm (1/4") between the sealing sleeve/top edge of the installed Protective Cover and the socket.
- ▶ If there is contact between the socket and the joint (hydraulic unit, frame) at maximum flexion, then the joint must be fitted with a flexion stop (e.g. in the case of voluminous residual limbs).  
If contact between the socket and joint (hydraulic unit, frame) occurs anyway at maximum flexion, the socket has to lie flat on the frame (with the help of soft padding on the socket).

**⚠ CAUTION**

**Insufficient insertion depth of the tube adapter**

Falling due to breakage of load-bearing components.

- ▶ Insert the tube adapter at least 40mm to ensure operational safety.
- ▶ The patient must be seated for length adjustments.

**⚠ CAUTION****Operator errors when using the adjustment software to adjust settings**

Fall due to unexpected prosthesis behaviour.

- ▶ Do not charge the prosthesis battery during the adjustment process since the prosthesis is not functional while the battery is being charged.
- ▶ During the adjustment process, the prosthesis must not remain unattended while connected to the software if it is being worn by the patient.
- ▶ Observe the maximum range of the Bluetooth connection and note that obstacles may limit this range.
- ▶ During the data transfer (PC to prosthesis), the prosthesis wearer should sit or stand still, and the BionicLink PC must not be removed from the computer.
- ▶ If you only want to make temporary changes to the settings while connected to the adjustment software, you must reverse these changes before disconnecting the adjustment software.  
You must also ensure the patient does not leave the range of the Bluetooth connection if settings have been changed temporarily.
- ▶ Inform the patient immediately if the data connection is accidentally interrupted during the adjustment process.
- ▶ The connection to the prosthesis must always be disconnected after adjustments have been completed.
- ▶ Successful participation on an Ottobock product training course is mandatory prior to initial use. Additional product training courses may be required to qualify for software updates.
- ▶ It is very important to enter the correct foot size, prosthesis dimensions and body weight in order to achieve a quality fitting. If the values are too high, the prosthesis may not switch to the swing phase. If the values are too low, the prosthesis may trigger the swing phase at the wrong time.
- ▶ If the patient uses walking aids (e.g., crutches or walking canes) during the adjustment process, you will need to readjust the settings when the patient no longer requires the respective aids.
- ▶ Use the online help function which is integrated into the software.
- ▶ Do not disclose your personal access data.

**⚠ CAUTION****Safety mode flexion resistance set too low**

Falling due to unexpected product behaviour as the result of switching into safety mode.

- ▶ Safety mode flexion resistance should be configured so that it is possible to stand safely without the knee joint buckling.

**4.7 Information on Proximity to Certain Areas****⚠ CAUTION****Insufficient distance to HF communication devices (e.g. mobile phones, Bluetooth devices, WiFi devices)**

Falling due to unexpected behaviour of the product caused by interference with internal data communication.

- ▶ Therefore, keeping a minimum distance of 30 cm to HF communication devices is recommended.

**⚠ CAUTION****Operating the product in very close proximity to other electronic devices**

Falling due to unexpected behaviour of the product caused by interference with internal data communication.

- ▶ Do not operate the product in the immediate vicinity of other electronic devices.
- ▶ Do not stack the product with other electronic devices during operation.
- ▶ If simultaneous operation cannot be avoided, monitor the product and verify proper use in the existing setup.

**⚠ CAUTION**

**Proximity to sources of strong magnetic or electrical interference (e.g. theft prevention systems, metal detectors)**

Falling due to unexpected behaviour of the product caused by interference with internal data communication.

- ▶ Ensure that the patient is not in the vicinity of sources of strong magnetic and electrical interference during trial fitting (such as theft prevention systems, metal detectors...).  
If this cannot be avoided, ensure at least that the patient has a safeguard when walking or standing (e.g. a handrail or the support of another person).
- ▶ In general, monitor the product for unexpected changes in the damping behaviour when electronic or magnetic devices are in the immediate vicinity.

**⚠ CAUTION**

**Entering a room or area with strong magnetic fields (e.g. magnetic resonance tomographs, MRT (MRI) equipment...)**

- > Falling due to unexpected restriction of the product's range of motion caused by metallic objects adhering to the magnetised components.
- > Irreparable damage to the product due to the effect of strong magnetic fields.
- ▶ Make sure that the patient takes off the product before entering the room or area and stores the product outside this room or area.
- ▶ Damage to the product caused by exposure to strong magnetic fields cannot be repaired.

**⚠ CAUTION**

**Remaining in areas outside the allowable temperature range**

Falling due to malfunction or the breakage of load-bearing product components.

- ▶ Ensure that the patient is not in areas outside the permissible temperature range (see page 48) during trial fitting.

**4.8 Information on Use**

**⚠ CAUTION**

**Walking up stairs**

Falling due to foot being placed incorrectly on stair as a result of changed damping behaviour.

- ▶ Inform the patient that the handrail always has to be used when walking up stairs, and that most of the sole of the foot has to be set onto the stair surface.
- ▶ Particular caution is required when carrying children up the stairs.

**⚠ CAUTION**

**Walking down stairs**

Falling due to foot being placed incorrectly on stair as a result of changed damping behaviour.

- ▶ Inform the patient that the handrail always has to be used when walking down stairs, and that the patient has to roll over the edge of the step with the middle of the shoe.
- ▶ The warnings and error signals have to be observed (see page 52).
- ▶ Notify the patient that resistance in the flexion and extension direction can change in case of warnings and error signals.
- ▶ Particular caution is required when carrying children down the stairs.

**⚠ CAUTION****Overheating of the hydraulic unit due to uninterrupted, increased activity (e.g. extended walking downhill)**

- > Falling due to unexpected behaviour of the product because of switching into overheating mode.
- > Burns due to touching overheated components.
- ▶ Be sure to pay attention when pulsating vibration signals start. They indicate the risk of overheating.
- ▶ As soon as these pulsating vibration signals begin, the activity level has to be reduced so the hydraulic unit can cool down.
- ▶ Full activity may be resumed after the pulsating vibration signals stop.
- ▶ If the activity level is not reduced in spite of the pulsating vibration signals, this could lead to the hydraulic element overheating and, in extreme cases, cause damage to the product. In this case, the product should be inspected by an authorised Ottobock Service Centre.

**⚠ CAUTION****Overloading due to unusual activities**

- > Falling due to unexpected product behaviour as the result of malfunction.
- > Falling due to breakage of load-bearing components.
- > Skin irritation due to defects on the hydraulic unit with leakage of liquid.
- ▶ The product was developed for everyday use and must not be used for unusual activities. These unusual activities include, for example, extreme sports (free climbing, paragliding, etc.).
- ▶ Careful handling of the product and its components not only increases their service life but, above all, ensures the patient's personal safety!
- ▶ If the product and its components have been subjected to extreme loads (e.g. due to a fall, etc.), then the product must be inspected for damage immediately. If necessary, forward the product to an authorised Ottobock Service Centre.

**⚠ CAUTION****Improper mode switching**

Falling due to unexpected behaviour of the product because of changed damping behaviour.

- ▶ Ensure that the patient stands securely during all switching processes.
- ▶ Inform the patient that the changed damping characteristics have to be verified after switching and feedback from the acoustic signal emitter must be observed.
- ▶ Switching back to basic mode is mandatory once the activities in MyMode have been completed.
- ▶ If required, take the weight off the product and correct the switching.

**⚠ CAUTION****Improper use of the stance function**

Falling due to unexpected product behaviour because of changed damping behaviour.

- ▶ Make sure that the patient is standing safely when using the stance function and checks the lock of the knee joint before placing his/her full weight on the prosthesis.
- ▶ Inform the patient whether and in what way the stance function was configured in the adjustment software. Information on the stance function see page 34.

**⚠ CAUTION****Quickly pushing the hip forward with the prosthesis extended (e.g. serve while playing tennis)**

- > Falling due to unexpected activation of the swing phase.
- ▶ Note that the knee joint may flex unexpectedly when the hip is pushed forward quickly while the prosthesis is extended.
- ▶ If the patient participates in sports where this movement pattern can occur, configure corresponding MyModes using the adjustment software. For further information about the MyModes, see the section 'MyModes' (see page 42).

**⚠ CAUTION**

**Overloading due to changes in body weight when carrying heavy objects, backpacks or children**

- > Falling due to unexpected behaviour of the product.
- > Falling due to breakage of load-bearing components.
- > Skin irritation due to defects on the hydraulic unit with leakage of liquid.
- ▶ Inform the patient that the behaviour of the product can change due to increased weight. It is possible that the swing phase may not be triggered, or triggered at the wrong time.
- ▶ Inform the patient that the maximum permissible body weight must not be exceeded due to the additional weight.

**4.9 Notes on the safety modes**

**⚠ CAUTION**

**Using the product in safety mode**

Falling due to unexpected product behaviour because of changed damping behaviour.

- ▶ The warnings/error signals (see page 52) have to be observed.
- ▶ Particular caution is necessary when using a bicycle without a freewheel (with a fixed gear).

**⚠ CAUTION**

**Safety mode cannot be activated due to malfunction caused by water penetration or mechanical damage**

Falling due to unexpected product behaviour because of changed damping behaviour.

- ▶ Using the product when it is defective is prohibited.
- ▶ The product must be inspected by an authorised Ottobock Service Centre.

**⚠ CAUTION**

**Safety mode cannot be deactivated**

Falling due to unexpected product behaviour because of changed damping behaviour.

- ▶ If safety mode cannot be deactivated by recharging the battery, a permanent error has occurred.
- ▶ Using the product when it is defective is prohibited.
- ▶ The product must be inspected by an authorised Ottobock Service Centre.

**⚠ CAUTION**

**Safety signal occurs (ongoing vibration)**

Falling due to unexpected product behaviour because of changed damping behaviour.

- ▶ The warnings/error signals (see page 52) have to be observed.
- ▶ After the safety signal has been emitted, further use of the product is prohibited.
- ▶ The product must be inspected by an authorised Ottobock Service Centre.

**4.10 Instructions for use with an osseointegrated implant system**

**⚠ WARNING**

**High mechanical loads due to normal or unusual situations, such as falling**

- > Overloading of the bone, which can lead to pain, loosening of the implant, necrosis or fracture among other things.
- > Damage or breakage of the implant system or its components (safety components...).
- ▶ Verify compliance with the fields of application, conditions of use and indications according to the information of the manufacturers, both for the knee joint and for the implant system.
- ▶ Note the instructions of the clinical personnel that indicated the use of the osseointegrated implant system.

## 4.11 Information on the use of a mobile device with the cockpit app

### ⚠ CAUTION

#### Improper use of the mobile device

Falling due to altered damping behaviour as a result of unexpected switching into a MyMode.

- ▶ Use the instructions for use (user) to instruct the patient on the proper handling of the mobile device with the Cockpit app.

### ⚠ CAUTION

#### Improper use of the setting parameters in the MyModes

Falling due to unexpected product behaviour because of changed damping behaviour.

- ▶ Instruct the patient regarding the functionality and adjustment options for **all parameters** of the MyModes.

### ⚠ CAUTION

#### Independently applied changes or modifications made to the mobile device

Falling due to altered damping behaviour as a result of unexpected switching to a MyMode.

- ▶ Do not make any independent changes to the hardware of the mobile device on which the app is installed.
- ▶ Do not make any independent changes to the software/firmware of the mobile device that are not included in the update function of the software/firmware.

### ⚠ CAUTION

#### Improper mode switching with the mobile device

Falling due to unexpected product behaviour because of changed damping behaviour.

- ▶ Ensure that the patient stands securely during all switching processes.
- ▶ Inform the patient that the changed damping characteristics have to be verified after switching, and feedback from the acoustic signal emitter and the mobile device display must be observed.
- ▶ Switching back to basic mode is mandatory once the activities in the MyMode have been completed.

### NOTICE

#### Failure to observe the system requirements for the installation of the Cockpit app

Mobile device malfunction.

- ▶ The Cockpit App should only be installed on mobile devices and versions which comply with the specifications in the respective online stores (e.g. Apple App Store, Google Play Store, ...)

### INFORMATION

The illustrations in these instructions for use are only examples and may deviate from the respective mobile device being used and the version.

## 5 Scope of Delivery and Accessories

### 5.1 Scope of delivery

- 1 pc. 3B5-3=ST Genium X3 (with threaded connector) or
- 1 pc. 3B5-3 Genium X3 (with pyramid) each with preinstalled 4X900 or 4X193-1 Genium X3 Protective Cover
- 1 pc. 2R19 AXON tube adapter
- 1 pc. 757L16-4 power supply
- 1 pc. 4E60\* inductive charger
- 1 pc. 4H102 15° X3 flexion stop
- 1 pc. 4H104\* 22.5° X3 flexion stop (already installed on delivery)
- 2 pc. M3x5 cap screws with Allen head (for installation of the supplied flexion stop and as replacement for the installed screws)
- 2 pc. M5x16 Torx screws (as replacement for the installed screws of the tube clamp)
- 1 pc. cosmetic case for battery charger and power supply
- 1 pc. 646C107 Bluetooth PIN card
- 1 pc. prosthesis passport
- 1 pc. Instructions for use (qualified personnel)
- 1 pc. Instructions for use (user)

Cockpit app for download from the website: <https://www.ottobock.com/cockpitapp>

- “4X441-V2=IOS Cockpit” iOS app
- “4X441-V2=ANDR Cockpit” Android app

## 5.2 Accessories

The following components are not included in the scope of delivery and may be ordered separately:

- Genium X3 Protective Cover: 4X900
- Genium X3 Protective Cover: 4X193-1
- 4H101 7.5° X3 flexion stop
- “4X1=V1.10 X-Soft” or higher adjustment software  
Update from 4X1=V1.0, V1.2, V1.6, V1.8 with Internet download

## 6 Charging the battery

The following points must be observed when charging the battery:

- Use the 757L16-4 power supply unit and 4E60\* battery charger to charge the battery.
- With average use, the capacity of the fully charged battery is sufficient for about 5 days.
- We recommend charging the product once a day when used by the patient on a daily basis.
- The battery should be charged for at least 3 hours prior to initial use.
- Note the permissible temperature range for charging the battery (see page 48).
- The distance between the battery charger and the receiver on the product must not exceed 2 mm.
- The tube adapter must be connected before disconnecting the battery charger, otherwise an error message will result (see page 52).

### 6.1 Connecting the power supply and battery charger



- 1) Slide the country-specific plug adapter onto the power supply until it locks into place (see fig. 1).
  - 2) Connect the round, **three-pin** plug of the power supply to the receptacle on the battery charger (see fig. 2) so that the plug locks into place.  
**INFORMATION: Ensure correct polarity (guide lug). Do not use force when connecting the cable plug to the battery charger.**
  - 3) Plug the power supply unit into the outlet (see fig. 3).
    - The green LED on the back of the power supply lights up.
    - The LED ring (status indicator) on the rear of the charger lights up green to indicate the correct connection to the power supply.
- If the green LED on the power supply and the LED ring on the battery charger do not light up, there is an error (see page 52).

### 6.2 Charging the prosthesis battery

#### INFORMATION

When the Protective Cover is installed, the battery charger cable has to point to the upper closure. A correct knee joint charging process is only ensured with this alignment.





- 1) Connect the inductive charger to the receiver of the charging unit on the rear of the product. The charger is held in place by a magnet.
  - The LED ring on the rear of the charger pulsates purple (4-second cycle).
  - If the LED ring lights up in a different colour, this indicates an error (see page 52).
- 2) The charging process starts.
  - Once the product battery is fully charged, all LEDs on the side of the battery charger light up.
- 3) After the charging process is complete, hold the prosthesis still and remove the inductive charger from the receiver.
  - A self-test is performed. The joint is operational only after corresponding feedback (see page 54).

#### INFORMATION

##### Charging the product without tube adapter

When the inductive charger is disconnected from the knee joint without the tube adapter, five beep and vibration signals are output. In order to avoid this, perform the following steps before disconnecting the charger:

- ▶ Hold the joint upright and flex the knee head 90°.
- ▶ Wait 5 seconds. The joint switches to energy saving mode.
  - The tube adapter can be disconnected without generating a warning signal.

## 6.3 Display of the current charge level

### 6.3.1 Display of battery charge level without additional devices

#### INFORMATION

The charge level cannot be displayed during the charging process, e.g. by turning the prosthesis over. The product is in charging mode.



- 1) Turn the prosthesis by 180° (the sole of the foot must face up).
- 2) Hold still for 2 seconds and wait for beep signals.

Beep signal	Battery charge level
5x short	more than 80%
4x short	60% to 80%
3x short	40% to 60%
2x short	20% to 40%
1x short	less than 20%

#### INFORMATION

If the **Volume** parameter is set to '0' in the Cockpit app (see page 37) or if mute mode (silent mode) is activated, there are no beep signals.

### 6.3.2 Display of the current charge level using the Cockpit app

Once the Cockpit app has been started, the current charge level is displayed in the bottom line of the screen:



1. 38% – Charge level of battery for currently connected component

### 6.3.3 Display of the current charge level during the charging process

During the charging process, the current battery charge level is indicated by the number of LEDs lit on the side of the charger.

	Quantity	Battery charge level
	0	0%-10%
	1	10%-30%
	2	30%-50%
	3	50%-70%
	4	70%-90%
5	> 90%	

## 7 Preparing the product for use

### 7.1 Alignment

The following alignment guidelines contain descriptions for connecting the knee joint to a prosthetic socket. In principle, the alignment of the prosthesis is independent of the type of connection for the knee joint. In case of a connection to an osseointegrated, percutaneous implant system, a socket is not used during bench alignment in the alignment apparatus. In this case, the central proximal point on the prosthetic socket corresponds to the trochanter of the thigh bone (see illustration in the section "Bench alignment in the alignment apparatus" see page 28).

Ensure that possible flexion or adduction of the transfemoral residual limb can be compensated to a permissible extent by an adapter approved by the implant manufacturer in the course of static alignment optimisation. Safe functioning of the knee joint is only guaranteed with biomechanically correct alignment.

#### INFORMATION

##### Disconnect tube adapter without error message

Five beep and vibration signals are output when the tube adapter is disconnected. In order to avoid this, perform the following steps while the tube adapter is connected:

- ▶ Hold the joint upright and flex the knee head 90°.
- ▶ Wait 5 seconds. The joint switches to energy saving mode.
  - The tube adapter can be disconnected without generating a warning signal.

### 7.1.1 Settings with the "X-Soft" adjustment software

#### 7.1.1.1 Introduction

The "X-Soft" adjustment software makes it possible to optimise the product settings for a patient. The adjustment software provides step-by-step guidance through the adjustment process. After the settings are configured, the data for them can be saved and printed for documentation. If needed, these data can be loaded and fed into the product.

You can consult the integrated online help of the adjustment software for further information.

#### INFORMATION

The **4X1 X-Soft adjustment software, version 1.10 or higher, is required** for correct alignment. If X-Soft is on hand in version 1.0 or higher, it can be updated.

#### INFORMATION

##### Non-use of the adjustment software

Swing phase initiation is not possible with the setting parameters on delivery (factory settings). Therefore, the settings of the product have to be checked using the adjustment software and changed as needed before the product is used for the first time, or after it is received from an authorised Ottobock Service Centre.

**INFORMATION**

**Additional text in the adjustment software when a patient weight  $\leq 150$  kg is entered in the adjustment software "Please note that the set patient weight exceeds the product specification!"**

A maximum body weight of 150 kg including additional weight is permissible with the current knee joint. Ensure this weight is not exceeded.

**Updating the X-Soft adjustment software**

- 1) Click "**Help > About**" in the menu bar of the Data Station when you are connected to the Internet.
  - The window opens with the versions of the previously installed programs and the manufacturer's address.
- 2) Click the "**Check for updates**" button in this window.
  - A search for updates of previously installed software products and components is performed via the Internet.
- 3) If updates are available, click "**Download**" in the column on the right in order to download and save the update.
- 4) Extract the "ZIP file" and execute it.

**7.1.1.2 Data transfer between the product and the PC**

Product settings using the adjustment software can only be made via Bluetooth data transfer. For this purpose, a Bluetooth wireless connection must be established between the product and the PC using the "60X5 BionicLink PC" Bluetooth adapter. The installation and use of the "60X5 BionicLink PC" adapter are described in the instructions for use supplied with the adapter.

**7.1.1.3 Preparing the product to connect to the adjustment software**

If the product does not emit any signals when querying the charge level (see page 25), the battery is drained or the product is switched off.

**Switching on the product**

- 1) Connect the power supply with battery charger to the wall socket.
  - 2) Connect the battery charger to the product.
  - 3) Wait for feedback signals.
  - 4) Disconnect the battery charger from the product.
- After feedback signals are emitted (self test), the product is switched on.

**Switching on Bluetooth**

Upon delivery the Bluetooth function of the prosthesis is switched on.

The Bluetooth function can be switched off using the Cockpit app or the adjustment software. When the Bluetooth function is switched off, it is only turned on temporarily for 2 minutes after connecting/disconnecting the battery charger and is then turned off again automatically. When a connection with the PC is active (the  symbol is lit up), the Bluetooth function is not switched off automatically.

**7.1.2 Removing the Protective Cover**

- 1) Open the closures.
- 2) Spread open the Protective Cover and remove it from the knee joint.
- 3) Fasten the two closures after removing the Protective Cover.

**7.1.3 Shortening the Tube Adapter****⚠ CAUTION****Incorrect processing of tube**

Falling due to damage to the tube.

- ▶ Do not clamp the tube into a vice.
- ▶ For shortening the tube, use only a tube cutter.

**⚠ CAUTION****Damage to the cable while shortening the tube adapter**

Falling due to unexpected product behaviour as the result of switching into safety mode.

- ▶ When shortening the tube adapter, make sure the cable does not get damaged.

- 1) Determine the required length of the tube adapter using the configuration assistant in the adjustment software.

- 2) Shorten the tube adapter to the determined value with the 719R3 tube cutter.
- 3) Store the tube adapter cable in the tube adapter. If this is not possible, the cable must be protected against damage.
- 4) Use a file (cut 2 (medium), e.g. 715H1=2 recommended) to file the cut edge smooth. Be careful of the tube adapter cable.  
**NOTICE! When filing or deburring, make sure that no metal shavings can get into the plug of the tube adapter cable.**
- 5) Chamfer the outside with a file.
- 6) Smooth the inside and outside of the cut edge with sandpaper (recommended grit 120).

#### 7.1.4 Installing the Tube Adapter

##### CAUTION

##### **Damage to the cable due to inserting the tube adapter too far**

Falling due to unexpected product behaviour as the result of switching into safety mode.

- ▶ To avoid damaging the cable, do not slide the tube adapter in to the stop, but only to a maximum of 70 mm.

##### CAUTION

##### **Improper assembly of the screw connections**

Falling due to breakage or loosening of the screw connections.

- ▶ Clean the threads before every installation.
- ▶ Apply the specified tightening torque values for installation (see the section "Technical data" see page 48).
- ▶ Observe the instructions for securing the screw connections and the use of the correct length.

- 1) Install the prosthetic foot on the tube adapter and tighten the **set screws on the tube adapter to a torque of 15 Nm**.  
**INFORMATION: The printed scale on the tube adapter must face forward.**
- 2) Connect the cable of the tube adapter to the cable of the knee joint.
- 3) Push the protruding cable loop back into the tube adapter. If the tube adapter has been shortened to the minimum length, the plug must be inserted in the cavity. The cable loop must then be stored carefully.
- 4) Insert the tube adapter about 60 mm into the knee joint (for the exact value, consult the configuration assistant in the adjustment software).  
**INFORMATION: Corrections in the insertion depth between 40 mm and 70 mm are permissible (slide in 10 mm and pull out 20 mm).**
- 5) Turn the foot outwards slightly and slightly tighten the two **distal tube clamp screws (approx. 4 Nm)**.  
**INFORMATION: After trial fitting, all screws have to be tightened alternately in several steps, increasing the tightening torque slowly until the prescribed tightening torque is reached (section "Technical data", see page 48).**

#### 7.1.5 Bench alignment in alignment apparatus

With correct bench alignment, e.g. in the PROS.A. assembly alignment apparatus (743A200), the benefits of the product are realised to best advantage. If the L.A.S.A.R. assembly alignment apparatus (743L200) is available, it can be used as well.

Alignment can also be carried out using LaserLine/plumb line.

A calibrated alignment recommendation for prosthesis bench alignment is provided in the adjustment software for the individual conditions of the prosthesis and patient. Therefore, consult the adjustment software for the alignment data.

The following points must be observed during alignment:

- Static alignment in the **alignment apparatus** must always be carried out **without shoes**, otherwise a correct adjustment will not be possible.
- Static alignment with the **LaserLine/plumb line** must be carried out **with shoes**, otherwise a correct adjustment will not be possible.
- Ensure the knee joint is in full extension during bench alignment. To do so, briefly push the socket once into the fully extended position.

#### 7.1.6 Static alignment optimisation

The adjustment software specifies concrete reference values based on measurement data to help optimise the alignment.

A precondition is that the alignment recommendations were followed during bench alignment of the prosthesis.

The goal of optimised alignment is that the user must compensate as little as possible with their residual limb. Optimised alignment of the prosthesis components can reduce the effort required from the patient.

#### INFORMATION

During static alignment optimisation, the knee joint is automatically locked in the flexion direction. This should enable the patient to stand in a stable stance that is unaffected by the alignment. Patients can only walk with the prosthetic leg fully extended in this situation!

### 7.1.7 Dynamic alignment optimisation

After adjusting the product with the adjustment software, perform dynamic optimisation during trial walking. Often, the following aspects have to be observed and adapted, if necessary:

- Socket flexion position by verifying step length symmetry (sagittal plane)
- Adduction position of the socket and M-L positioning of the socket adapter (frontal plane)
- Rotation position of the knee joint axis and outward rotation of the prosthetic foot (transversal plane)

### 7.1.8 Protective Cover Installation

- 1) Open the closures.
- 2) Spread open the Protective Cover.
- 3) Apply the Protective Cover to the knee joint.
- 4) Fasten the upper closure.
  - Squeeze the Protective Cover together slightly with both hands.
  - Push back the upper closure with your thumb.
- 5) Fasten the lower closure.

#### NOTICE

#### Loss of stability due to inadequately installed retainers

No hold of the Protective Cover on the knee joint.

- ▶ Ensure that all retainers and closures are properly engaged and/or fastened.

### 7.1.9 Checking the socket after bench alignment

After bench alignment, verify that at maximum extension and maximum flexion the distance from the socket to the knee joint is not less than the minimum. A collision of the socket with the hydraulics or frame can cause damage to the knee joint.

#### INFORMATION

#### Checking the distance using the adjustment software

Checking the distance between the socket and hydraulics at maximum flexion is also supported by the "X-Soft" adjustment software starting with version "V1.10". See the online help of the adjustment software for further information.

### Verification at maximum flexion

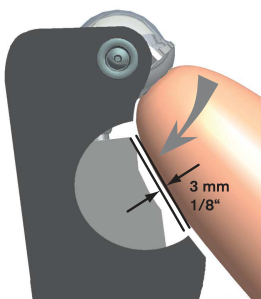

If the distance between the socket and hydraulics is not sufficient, the hydraulics may be damaged. Check the distance as follows:

- 1) Bring the knee joint with socket to maximum flexion.
- 2) Check the available distance between the hydraulics and socket. It must be at least 3 mm.

**INFORMATION: If the distance is less, a flexion stop has to be installed or an existing flexion stop replaced with a larger one. For information on the flexion stop, see the next section.**

**Verification at maximum extension**

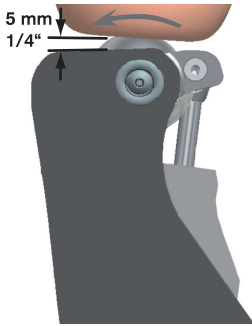

If the distance between the socket and sealing sleeve/top edge of the installed protective cover is not sufficient, the frame may be damaged. Check the distance as follows:

- 1) Bring the knee joint with socket to maximum extension.
- 2) Check the available distance between the sealing sleeve/top edge of the installed protective cover and socket. It must be at least 5 mm.

**7.1.10 Flexion stop**

The knee joint comes fitted with a flexion stop upon delivery. This reduces the maximum flexion angle by 22.5°, thus preventing the socket from coming into contact with the hydraulics.

To limit the flexion angle, the knee joint can be equipped with the following flexion stops:

- 4H101 X3 flexion stop (optional accessory): reduction of the maximum flexion angle by 7.5°
- 4H102 X3 flexion stop (in scope of delivery): reduction of the maximum flexion angle by 15°
- 4H104\* X3 flexion stop (already installed on delivery): reduction of the maximum flexion angle by 22.5°

The flexion stop can be removed to increase the flexion angle. In this case, it must be ensured that the socket and the hydraulic unit do not collide (see page 29).



**Removing the flexion stop**

- 1) Use an appropriate screwdriver to loosen the screws on the flexion stop (left and right of the piston rod).
- 2) Remove the flexion stop and screws from the joint.

**INFORMATION: Do not insert the screws without the flexion stop!**



**Inserting the flexion stop**

- 1) Insert the flexion stop.
- 2) Securing the screws with 636K13 thread lock.
- 3) Insert the screws.
- 4) Tighten the screws to 0.6 Nm with the 710D17 torque wrench.

**INFORMATION**

**Always use screws of similar type on the same flexion stop**

When installing the screws, make sure that screws of similar type are always used on the same flexion stop. Using a cap screw and a countersunk screw together to install the flexion stop is not permitted.

**8 Cockpit app**



The cockpit app enables switching from basic mode into the pre-configured MyModes. In addition, information about the product (step counter, battery charge level, etc.) can be called up.

The behaviour of the product can be changed to a certain extent on a day-to-day basis using the app (e.g. while becoming accustomed to the product). The adjustment software can be used to trace the change at the patient's next appointment.

## Information on the Cockpit app

- The Cockpit app can be downloaded free of charge from the respective online store. For more information, please visit the following website: <https://www.ottobock.com/cockpitapp>. To download the Cockpit app, the QR code on the supplied Bluetooth PIN card can also be read with the mobile device (requirement: QR code reader and camera).
- The language of the user interface in the Cockpit app can be changed using the adjustment software.
- Depending on the version of the Cockpit app being used, the language of the user interface in the Cockpit app corresponds to the language of the mobile device on which the Cockpit app is being used.
- The serial number of the component to be connected has to be registered with Ottobock the first time it is connected. If the registration is not accepted, use of the Cockpit app for this component will be limited.
- Bluetooth on the prosthesis must be turned on in order to use the Cockpit app.  
If Bluetooth is switched off, it can be turned on by turning the prosthesis upside-down (sole of the foot must point up) or by connecting/disconnecting the battery charger. Bluetooth is then turned on for approx. 2 minutes. During this time, the app must be started and used to establish a connection. If required, Bluetooth on the prosthesis can be switched on permanently afterwards (see page 40).
- Keep the mobile app up to date at all times.
- Please contact the manufacturer if you suspect cybersecurity problems.

## 8.1 System Requirements

See the information in the Apple App Store or Google Play Store regarding compatibility with mobile devices and versions.

## 8.2 Initial connection between cockpit app and prosthesis



**The following points need to be observed before establishing the connection:**

- Bluetooth of the component must be switched on (see page 40).
- Bluetooth on the mobile device must be switched on.
- The mobile device must not be in "flight mode" (offline mode), otherwise all wireless connections are turned off.
- **The mobile device must be connected to the Internet.**
- The serial number and Bluetooth PIN of the component being connected must be known. They are found on the enclosed Bluetooth PIN card. The serial number begins with the letters "SN".

### INFORMATION

If the Bluetooth PIN card with the Bluetooth PIN and serial number of the component is lost, the Bluetooth PIN can be determined using the adjustment software.

### 8.2.1 Starting the cockpit app for the first time

- 1) Tap the symbol of the Cockpit app (  ).  
→ The end user license agreement (EULA) is displayed.
  - 2) Accept the end user license agreement (EULA) by tapping the **Accept** button. If the end user license agreement (EULA) is not accepted, the Cockpit app cannot be used.  
→ The welcome screen appears.
  - 3) Hold the prosthesis with the sole of the foot facing up, or connect and then disconnect the battery charger, in order to activate recognition (visibility) of the Bluetooth connection for 2 minutes.
  - 4) Tap the **Add component** button.  
→ The Connection Wizard opens and guides you through the process of establishing a connection.
  - 5) Follow the subsequent instructions on the screen.
  - 6) After the Bluetooth PIN is entered, a connection to the component is established.  
→ While the connection is being established, 3 beep signals sound and the  symbol appears.  
The  symbol is displayed when the connection has been established.
- Once the connection has been established, the data are read from the component. This process may take up to a minute.  
Then the main menu appears with the name of the connected component.

### INFORMATION

After the initial connection to the component has been established successfully, the app will connect automatically each time it is started. No further steps are required.



**INFORMATION**

After activating the "visibility" of the component (holding the component with the sole of the foot facing up, or connecting and then disconnecting the battery charger), the component can be recognised by another device (e.g. smartphone) within 2 minutes. If registration or establishing the connection takes too long, the process of establishing a connection is cancelled. In this case, hold the component with the sole of the foot facing up again, or connect and then disconnect the battery charger.

### 8.3 Control elements for cockpit app

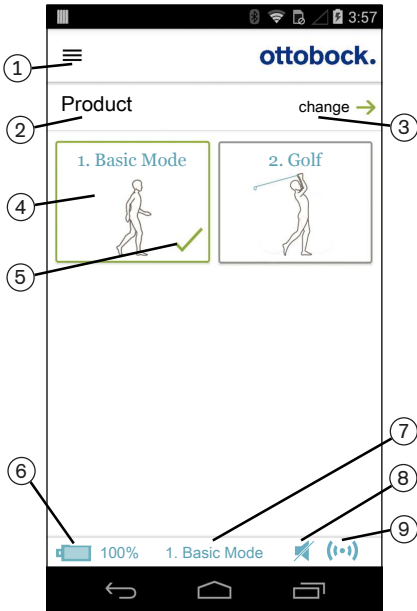

1. ☰ Access the navigation menu (see page 32)
2. Product  
The component name can only be changed with the adjustment software.
3. If connections to more than one component have been saved, you can switch between the saved components by tapping the entry **change**.
4. MyModes configured with the adjustment software.  
Switching the mode by tapping the corresponding symbol and confirming by tapping "OK".
5. Currently selected mode
6. Charge level of the component.
  - 🔋 Component battery fully charged
  - 🔌 Component battery empty
  - 🔌🔋 Component battery is being charged
 The current charge level is also displayed in %.
7. Display and name of the currently selected mode (e.g. **1. Basic Mode**)
8. 🔇 Mute mode is activated
9. (•••) Connection to component has been established  
(⊗) Connection to component has been interrupted. The app is attempting to re-establish the connection automatically.  
🔌 No existing connection to the component.

#### 8.3.1 Cockpit app navigation menu

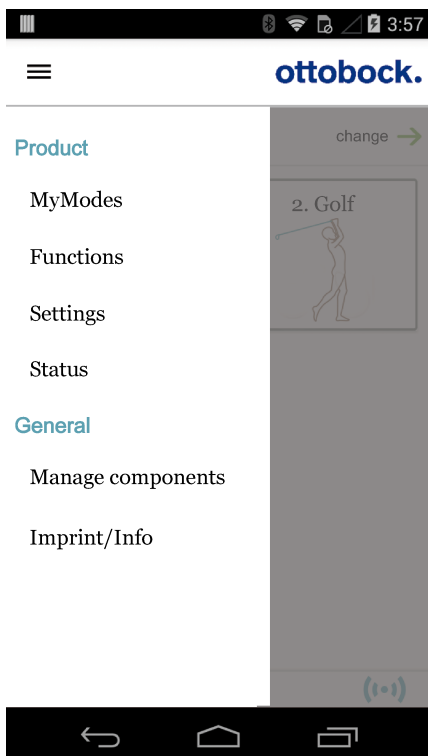

Tap the ☰ symbol in the menus to display the navigation menu. Additional settings for the connected component can be configured in this menu.

**Product**

Name of the connected component

**MyModes**

Return to the main menu to switch MyModes

**Functions**

Call up additional functions of the component (e.g. turn off Bluetooth) (see page 40)

**Settings**

Change settings of the currently selected mode (see page 37)

**Status**

Query status of the connected component (see page 40)

**Manage components**

Add or delete components (see page 33)

**Imprint/Info**

Display information/legal notices for the cockpit app





## 8.4 Managing components

Connections with up to four different components can be stored in the app. However, a component can only be connected to one mobile device at a time.

### INFORMATION

Before establishing the connection, observe the points in the section "Initial connection between Cockpit app and component" (see page 31).

### 8.4.1 Adding component

- 1) Tap the ☰ symbol in the main menu.
  - The navigation menu opens.
- 2) In the navigation menu, tap the entry "**Manage components**".
- 3) Hold the prosthesis with the sole of the foot facing up, or connect and then disconnect the battery charger, in order to activate recognition (visibility) of the Bluetooth connection for 2 minutes.
- 4) Tap the "+" button.
  - The Connection Wizard opens and guides you through the process of establishing a connection.
- 5) Follow the subsequent instructions on the screen.
- 6) After the Bluetooth PIN is entered, a connection to the component is established.
  - While the connection is being established, 3 beep signals sound and the  symbol appears. The  symbol is displayed when the connection has been established.
  - Once the connection has been established, the data are read from the component. This process may take up to a minute. Then the main menu appears with the name of the connected component.

### INFORMATION

If establishing a connection to a component is not possible, perform the following steps:

- ▶ Delete the component from the Cockpit app if applicable (see the section "Deleting a component")
- ▶ Add the component again in the Cockpit app (see the section "Adding a component")

### INFORMATION

After activating the "visibility" of the component (holding the component with the sole of the foot facing up, or connecting and then disconnecting the battery charger), the component can be recognised by another device (e.g. smartphone) within 2 minutes. If registration or establishing the connection takes too long, the process of establishing a connection is cancelled. In this case, hold the component with the sole of the foot facing up again, or connect and then disconnect the battery charger.

### 8.4.2 Deleting a component

- 1) Tap the ☰ symbol in the main menu.
  - The navigation menu opens.
- 2) In the navigation menu, tap the entry "**Manage components**".
- 3) Tap the "**Edit**" button.
- 4) Tap the  symbol under the component you want to delete.
  - The component is deleted.

### 8.4.3 Connecting component with multiple mobile devices

The connection for a component can be stored on more than one mobile device. However, only one mobile device can be connected to the component at one time.

If there is an existing connection between the component and a different mobile device, the following information appears while the connection is being established with the current mobile device:

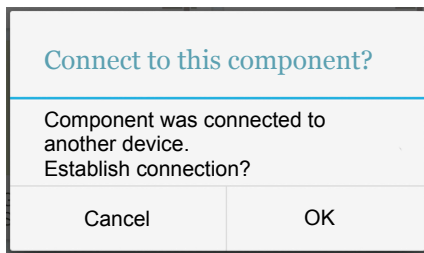

- ▶ Tap the "OK" button.
- The connection to the last connected mobile device is broken off and established with the current mobile device.

## 9 Use

### 9.1 Movement patterns in basic mode (mode 1)

#### 9.1.1 Standing

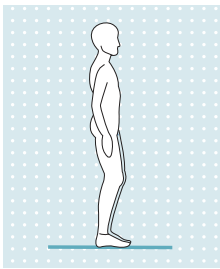

Knee control through high hydraulic resistance and static alignment.

A stance function can be enabled using the adjustment software. Please see the following section for further information on the stance function.

##### 9.1.1.1 Stance function

###### INFORMATION

To use this function, it needs to be enabled in the adjustment software. It also has to be activated using the Cockpit app (see page 38).

The stance function (standing mode) is a functional supplement to the basic mode (mode 1). This function makes it easier, for example, to stand on an inclined surface for a longer time. The joint is fixed in the flexion direction.

This function must be enabled in the adjustment software. Once the function is enabled, you can also choose between an intuitive and a conscious lock.

##### Intuitive locking of the joint

The intuitive stance function recognises any situation that puts strain on the prosthesis in the flexion direction but where flexion is not permitted. Examples of this include standing on uneven or sloping surfaces. The knee joint is always locked in the flexion direction when the prosthetic leg is not fully extended, under some amount of load and at rest. Upon forward or backward rollover or extension, the level of resistance is immediately reduced to stance phase resistance again.

The knee joint is not locked when the above conditions are met and a sitting position is assumed (for example while driving).

##### Deliberate locking of the joint

- 1) Assume the desired knee angle.
- 2) Do not remove the entire load from the prosthesis.
- 3) Do not change the knee angle for a brief period (1/8 second). This time period prevents unintentional activation of the stance function while walking.

→ The blocked joint can now be loaded in the flexion direction.

##### Deliberate unlocking of the joint

- ▶ By deliberately extending or unloading the knee joint, it is unlocked again.

###### INFORMATION

##### Stance function with hip disarticulation amputation level

Due to personal abilities and experiences with prostheses, these patients may encounter difficulties with activating/deactivating the stance function. If these patients want to stand with a flexed and locked knee joint for extended periods of time, a MyMode can be configured that can be activated/deactivated using the Cockpit app.

### 9.1.2 Walking

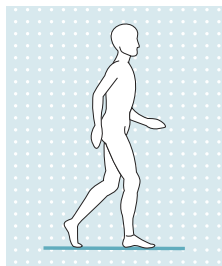

Initial attempts at walking with the prosthesis always require the instruction of trained, qualified personnel.

The hydraulics stabilise the knee joint in the stance phase and release the knee joint in the swing phase so that the leg can swing forward freely.

Switching to the swing phase requires that the prosthesis roll over to the front out of the stride position.

### 9.1.3 Running short distances ("walk-to-run" function)

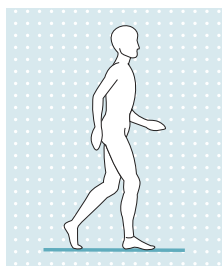

For covering short distances quickly, the knee joint detects a transition from walking to running in basic mode and automatically changes the following settings:

- The swing phase angle is increased
- Preflexion of 4° at heel strike (PreFlex) is reduced to 0°

The requirements to automatically switch to the running motion are fast forward movement of the prosthetic leg and high dynamic load on the knee joint. When stopping from the running motion, the changed settings are set back to the standard values.

#### INFORMATION

For covering longer distances, a "Running" MyMode can be configured using the adjustment software (see page 42).

### 9.1.4 Sitting down

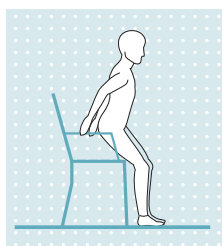

The resistance in the prosthetic knee joint while sitting down ensures even bending into the sitting position.

The adjustment software can be used to configure whether the sitting process is to be supported or not.

- 1) Place both feet side by side at the same level.
- 2) While sitting down, weight should be distributed evenly between both legs and the arm supports used where applicable.
- 3) Move the buttocks in the direction of the back support and lean the upper body forward.

**INFORMATION: Resistance while sitting down can be changed with the Cockpit app via the parameter "Resistance" (see page 38).**

### 9.1.5 Sitting

#### INFORMATION

While sitting, the knee joint also switches to energy saving mode. This energy saving mode is activated regardless of whether the sitting function is activated or not.

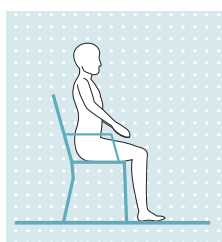

If the patient is in a sitting position for more than two seconds (i.e. the thigh is close to horizontal and there is no load on the leg), the knee joint switches the resistance to a minimum in the extension direction.

A sitting function can be enabled using the adjustment software. For more information about the sitting function, see the following section.

#### 9.1.5.1 Sitting function

#### INFORMATION

To use this function, it needs to be enabled in the adjustment software. It also has to be activated using the Cockpit app (see page 38).

In the sitting position, the resistance in the flexion direction is reduced in addition to the reduction of resistance in the extension direction. This makes it possible to swing the prosthetic leg freely.

### 9.1.6 Standing up

Flexion resistance is increased steadily while standing up.

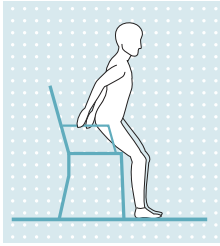

- 1) Place the feet at the same level.
- 2) Lean the upper body forward.
- 3) Put the hands on armrests, if available.
- 4) Stand up with support from the hands while keeping weight evenly distributed on feet.

### 9.1.7 Walking up stairs step-over-step

#### INFORMATION

To use this function, it needs to be enabled in the adjustment software. It also has to be activated using the Cockpit app (see page 38).

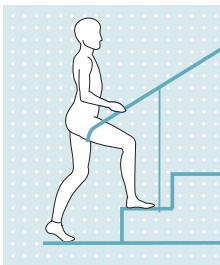

Although the knee joint is passive, which means it cannot actively initiate movements, negotiating stairs step-over-step is possible.

This function must be practised and executed consciously.

- 1) Lift the extended prosthesis off the floor.
- 2) Immediately after lifting the extended leg off the floor, extend the hip briefly and then abruptly flex it. This requires a sufficiently secure hold in the socket and a certain level of residual limb strength.
  - This whip motion flexes the knee, because the knee joint automatically recognises the movement and sets the flexion resistance to minimum.

#### INFORMATION: Take note of people behind you before executing the whip motion.

- 3) When sufficient knee flexion has been achieved, the knee joint increases extension resistance so that there is enough time to position the foot on the next step before the knee joint is extended again.
- 4) Set the foot onto the next step.
 

The support area for the foot on the step must be large enough that the heel does not extend back too far over the edge. With too little support area, the lower leg would extend too early and position the leg too far backwards. In this phase, the knee joint has already set the flexion resistance to maximum (blocked). The knee joint can no longer be flexed but only extended. This ensures that the leg does not buckle if the hip strength is not sufficient for the extending motion.
- 5) Support yourself with your hand on the contralateral side. A smooth wall will also work. This lateral support is intended to prevent the residual limb from twisting in the socket. Twisting can lead to unpleasant surface tension between the skin and the socket. Lateral support also improves balance.
- 6) Bring the knee into extended position. When the knee joint is fully extended, the initial position has been reached.
- 7) You can climb the next step or continue walking normally.

### 9.1.8 Overcoming obstacles

#### INFORMATION

To use this function, it needs to be enabled in the adjustment software. It also has to be activated using the Cockpit app (see page 38).

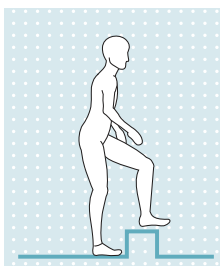

The stair function can also be used to cross obstacles:

- 1) Lift the extended prosthesis off the floor.
- 2) Briefly extend the hip.
- 3) Quickly flex the hip. This causes the knee to flex.
- 4) With the knee flexed, step over the obstacle.

With sufficient knee flexion, the extension resistance is increased to allow enough time for crossing the obstacle.

### 9.1.9 Walking down stairs

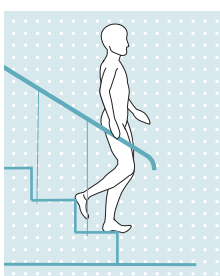

This function must be practised and executed consciously. Only when the sole is properly positioned can the knee joint react correctly and permit controlled flexion.

- 1) Hold the handrail with one hand.
- 2) Position the leg with the prosthesis on the step so that the foot projects halfway over the edge of the step.
  - This is the only way to ensure a secure rollover.
- 3) Roll the foot over the edge of the step.
  - This flexes the prosthesis slowly and evenly in the knee joint.
- 4) Place the foot of the other leg onto the next step.
- 5) Place the foot of the prosthetic leg on the next step after that.

**INFORMATION: The flexion speed of the knee joint can be changed using the Cockpit app via the parameter "Resistance" (see page 38).**

### 9.1.10 Walking down a ramp

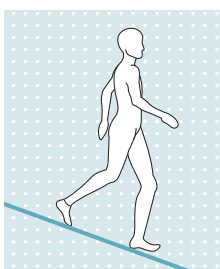

Under increased flexion resistance, permit controlled flexion of the knee joint which lowers the body's centre of gravity.

**INFORMATION: The flexion resistance at which the knee bends can be changed using the Cockpit app via the parameter "Resistance" (see page 38).**

### 9.1.11 Configuration for walking down stairs/ramp using the adjustment software

Walking down stairs or ramps can be configured as follows using the adjustment software:

Parameter	Meaning
Supported	Flexion resistance that increases with the knee angle (starting from the resistance of the parameter " <b>Stance flexion resistance</b> ") to the end of the stance phase is configured.
Dynamic	With this setting, it is possible to swing the prosthesis up at the end of the stance phase on ramps and stairs. This results in more ground clearance during swing-through of the prosthesis.

## 9.2 Changing prosthesis settings



Once an active connection to a component has been established, the settings **of the respective active mode** can be changed using the Cockpit app.

### INFORMATION

Bluetooth on the prosthesis must be switched on to change the prosthesis settings.

If Bluetooth is switched off, it can be turned on by turning the prosthesis upside-down or by connecting/disconnecting the battery charger. Bluetooth is then turned on for approx. 2 minutes. The connection must be established during this period.

**Information for changing the prosthesis settings**

- Before changing settings, always check the main menu of the Cockpit app to make sure the correct component has been selected. Otherwise parameters could be changed for the wrong component.
- It is not possible to change prosthesis settings nor to switch to a different mode while the prosthesis battery is being charged. Only the status of the prosthesis can be called up. Instead of the  symbol, the  symbol appears in the bottom row of the screen in the cockpit app.
- The O&P professional’s setting is in the middle of the scale. After making adjustments, this setting can be restored by tapping the “**Standard**” button in the Cockpit app.
- Prosthesis settings should be optimised using the adjustment software. The Cockpit app is not intended for use by the O&P professional to set up the prosthesis. The patient can use the app to change the behaviour of the prosthesis to a certain extent during everyday use (e.g. while becoming accustomed to the prosthesis). The O&P professional can use the adjustment software to track these changes at the patient’s next appointment.
- If the settings of a MyMode are to be modified, one must first switch to this MyMode.

**9.2.1 Changing the prosthesis setting using the cockpit app**

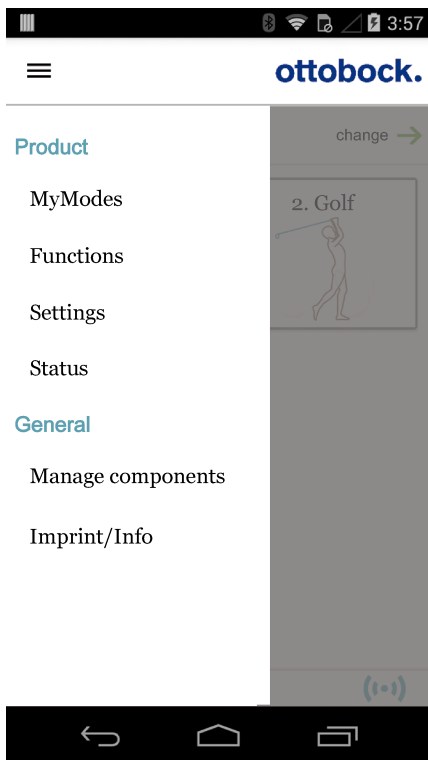

- 1) Once the component is connected and in the desired mode, tap the  icon in the main menu.  
→ The navigation menu opens.
- 2) Tap the “**Settings**” menu option.  
→ A list appears with the parameters for the currently selected mode.
- 3) Change the setting of the desired parameter by tapping the “<”, “>” icons.

**INFORMATION: The O&P professional’s setting is marked and, after the setting has been changed, can be restored by tapping the “Standard” button.**

**9.2.1.1 Overview of adjustment parameters in basic mode**

**INFORMATION**  
When mute mode (silent mode) is activated, no beep and vibration signals are generated.

The parameters in basic mode describe the dynamic behaviour of the prosthesis in a normal gait cycle. These parameters act as basic settings for automatically adjusting the damping behaviour to the current motion situation (e.g. ramps, slow walking speed, etc.).

The stance function, sitting function and/or stairs and obstacles function can also be activated/deactivated. Further information on the stance function (see page 34), sitting function (see page 35), stairs and obstacles function (see page 36).

**The following parameters can be modified:**

Parameter	Adjustment software range	Setting range, app	Meaning
Resistance	120 – 180	+/- 10	Resistance against flexion motion e.g. when walking down stairs or when sitting down
Angle	55° – 70°	+/- 3°	Maximum flexion angle in the swing phase

Parameter	Adjustment software range	Setting range, app	Meaning
Stance function	Deactivated Activated	0 - deactivated 1 - activated	Activation/deactivation of the stance function. For switching with the Cockpit app, this function has to be activated in the adjustment software. Further information (see page 34).
Sitting function	Deactivated Activated	0 - deactivated 1 - activated	Activation/deactivation of the sitting function. For switching with the Cockpit app, this function has to be activated in the adjustment software. Further information (see page 35).
Stair Function	Deactivated Activated	0 - deactivated 1 - activated	Activating/deactivating the stair and obstacle function. For switching with the Cockpit app, this function has to be activated in the adjustment software. Further information (see page 36).
Pitch	1000 Hz 4000 Hz	– 1000 Hz – 4000 Hz	Pitch of beep signal for confirmation tones
Volume	0 – 4	0 – 4	Volume of beep signal for confirmation tones (e.g. when checking the charge level, switching MyModes). The "0" setting deactivates the audible feedback signals. However, warning signals in case of errors are still generated.

### 9.2.1.2 Overview of adjustment parameters in MyModes

#### ⚠ CAUTION

#### Improper use of the setting parameters in the MyModes

Falling due to unexpected product behaviour because of changed damping behaviour.

► Instruct the patient regarding the functionality and adjustment options for **all parameters** of the MyModes.

#### INFORMATION

When mute mode (silent mode) is activated, no beep and vibration signals are generated.

The parameters in the MyModes describe the static behaviour of the prosthesis for a specific movement pattern such as cycling. Damping behaviour is not automatically controlled and adjusted in MyModes.

Parameter	Adjustment software range	Setting range, app	Meaning
Basic flex.	0–200	+/- 20	Level of flexion resistance at the start of flexing the knee joint
Gain	0–100	+/- 10	Increase in flexion resistance (starting with the parameter " <b>Basic flex.</b> ") when flexing the knee joint. The knee joint locks at a certain flexion angle, which depends on the setting of the parameters " <b>Basic flex.</b> " and " <b>Gain</b> ".
Basic ext.	0–60	+/- 20	Level of extension resistance
Locking angle	0–90	+/- 10	Angle up to which the knee joint can be extended. <b>Information:</b> If this parameter is >0, the knee joint is locked in a flexed position in the extension direction. To unlock it, unload the prosthesis and tilt it back for at least 1.5 seconds. This makes extension of the joint possible independently of the settings for the parameters " <b>Basic ext.</b> " and " <b>Locking angle</b> ". This may be necessary to switch to basic mode using a movement pattern.
Pitch	1000 Hz–4000 Hz	1000 Hz–4000 Hz	Pitch of beep signal for confirmation tones

Parameter	Adjustment software range	Setting range, app	Meaning
Volume	0–4	0–4	Volume of beep signal for confirmation tones (e.g. when checking the charge level, switching MyModes). The "0" setting deactivates the audible feedback signals. However, warning signals are still generated if errors occur.

### 9.3 Turning Bluetooth on the prosthesis on/off

#### INFORMATION

Bluetooth on the prosthesis must be turned on in order to use the Cockpit app.

If Bluetooth is switched off, it can be turned on by turning the prosthesis upside-down (function only available in basic mode) or by connecting/disconnecting the battery charger. Bluetooth is then turned on for approx. 2 minutes. During this time, the app must be started and used to establish a connection. If required, Bluetooth on the prosthesis can be switched on permanently afterwards (see page 40).

#### INFORMATION

Basic mode (mode 1) has to be active to turn off Bluetooth. If a MyMode is activated, one has to switch to basic mode to turn off Bluetooth.

#### 9.3.1 Switching Bluetooth off/on using the cockpit app

##### Switching off Bluetooth

- 1) When the component is connected, tap the ☰ symbol in the main menu.  
→ The navigation menu opens.
- 2) In the navigation menu, tap the entry "**Functions**".
- 3) Tap the entry "**Deactivate Bluetooth**".
- 4) Follow the on-screen instructions.

##### Switching on Bluetooth

- 1) Turn the component over or connect/disconnect the battery charger.  
→ Bluetooth is switched on for approx. 2 minutes. During this time, the app must be started in order to establish a connection to the component.
- 2) Follow the on-screen instructions.  
→ If Bluetooth is switched on, the (•••) symbol appears on the screen.

### 9.4 Querying the prosthesis status

#### 9.4.1 Query status through cockpit app

- 1) When the component is connected, tap the ☰ symbol in the main menu.
- 2) In the navigation menu, tap the entry "**Status**".

#### 9.4.2 Status display in the cockpit app

Menu option	Description	Possible actions
Trip	Daily step counter (steps with the prosthesis side)	Reset the counter by tapping the " <b>Reset</b> " button.
Step	Total step counter (steps with the prosthesis side)	For informational purposes only
Service	Display of the next maintenance date	For informational purposes only
Batt.	Current prosthesis charge level, as a percentage	For informational purposes only
Stb/Act: 58/29	Estimated remaining operating time of prosthesis in hours. Rest mode (Stb) e.g. 58 hours, active use (Act) e.g. 29 hours	For informational purposes only



## 9.5 Mute mode (silent mode)

Activating mute mode (silent mode) turns off the audible feedback signals and the vibration signals. However, warnings in case of component errors are still generated (see page 52).

Mute mode can be activated/deactivated using the Cockpit app.

### INFORMATION

Connecting the battery charger automatically deactivates mute mode again.

### 9.5.1 Turning mute mode on/off using the Cockpit app

- 1) When the component is connected, tap the ☰ symbol in the main menu.
  - The navigation menu opens.
- 2) In the navigation menu, tap the entry "**Functions**".
- 3) Tap the entry "**Mute mode**".
- 4) Follow the on-screen instructions.

## 9.6 Deep sleep mode

### INFORMATION

When mute mode (silent mode) is activated, no beep and vibration signals are generated.

### INFORMATION

If the **Volume** parameter is set to '0' in the Cockpit app, there are no beep signals (see page 37).

The Cockpit app can be used to place the knee joint into a deep sleep mode, in which power consumption is minimised. The knee joint offers no functionality in this mode. The safety mode damping values are activated.

It can be awakened from deep sleep mode with the Cockpit app or by connecting the battery charger. Waking from deep sleep mode using the Cockpit app can take up to 30 seconds.

After ending deep sleep mode, the knee joint is in basic mode again.

### 9.6.1 Turning deep sleep mode on/off using the Cockpit app

#### Activating deep sleep mode

- 1) When the component is connected, tap the ☰ symbol in the main menu.
    - The navigation menu opens.
  - 2) In the navigation menu, tap the entry "**Functions**".
  - 3) Tap the entry "**Activate deep sleep mode**".
  - 4) Follow the on-screen instructions.
- The activation of deep sleep mode is indicated by a short beep signal and a short vibration signal, assuming that mute mode (silent mode) is not active.

#### Deactivating deep sleep mode

- 1) When deep sleep mode is active for the currently connected prosthesis, the **Exit deep sleep mode** button automatically appears when the Cockpit app is started.
- 2) Tapping this button establishes a connection to the prosthesis and deactivates deep sleep mode.

**INFORMATION: Establishing a connection in deep sleep mode can take up to 30 seconds.**

If a prosthesis is in deep sleep mode but not connected to the Cockpit app, a connection to the prosthesis has to be established (see page 33).

## 9.7 OPG function (Optimised Physiological Gait)

### INFORMATION

The "PreFlex" function can be activated/deactivated using the adjustment software. All other parameters of the OPG function are always active and cannot be influenced.

The OPG function minimises the prosthesis wearer's prosthetic deviations from a harmonious gait pattern and promotes more biomechanically correct walking. This function enables the following features:

#### PreFlex

PreFlex ensures the knee is in 4° of flexion at the end of swing phase in preparation for loading response. This makes initiating stance phase flexion easier and forward movement is less restricted.

### Adaptive yielding control

The knee joint has auto-adaptive stance and swing extension resistance. The stance flexion resistance experienced by the user is dependent on the slope or incline when walking downhill. When walking on a ramp, adaptive yielding control manages flexion depending on the angle of the ramp. The knee joint flexes slowly if the ramp is flat, and flexes quickly if the ramp is steep.

### Dynamic stability control (DSC)

DSC ensures the knee will not release stance resistance during biomechanically unstable static and dynamic conditions. Constantly checking multiple parameters, DSC ensures the optimally timed decision for the knee to safely switch from stance to swing. Because DSC is always monitoring knee function, multi-directional movement and walking backward are also possible without risk of stance resistance releasing.

### Adaptive swing phase control

Instantaneous adaptation to varied walking cadences and to changes of the pendular mass (e.g. varying footgear) ensures the knee always achieves the swing flexion target angle within (+/-) one degree. The swing phase extension and flexion resistance experienced by the user are auto-adaptive.

The flexed and partially loaded knee will also disable the stance phase on slopes and ramps to allow for greater knee flexion and more ground clearance in the swing phase.

## 10 MyModes

In addition to basic mode (mode 1), up to 5 MyModes can be activated and configured with the adjustment software. They can be called up by the patient using the Cockpit app. Only the first 3 MyModes can be selected using movement patterns. Switching by using movement patterns has to be activated in the adjustment software.

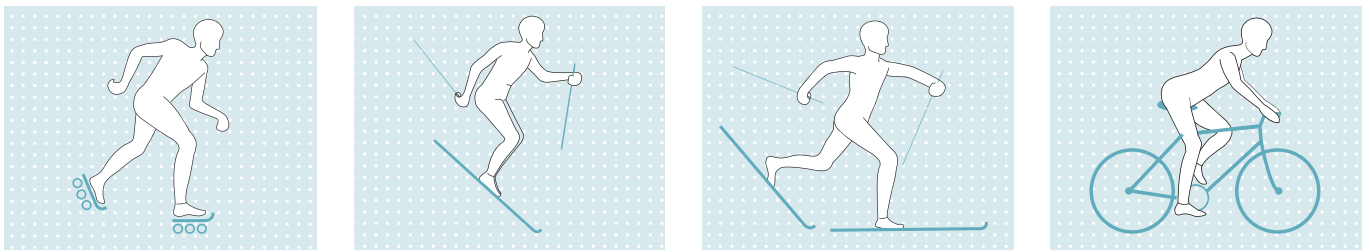

These modes are intended for specific motion patterns or postures (e.g. inline skating, running (jogging) ...). Default settings for these motion patterns and postures can be called up and individually adapted using the adjustment software.

Settings can also be adjusted by the patient using the Cockpit app (see page 39).

### 10.1 Running function as configured MyMode

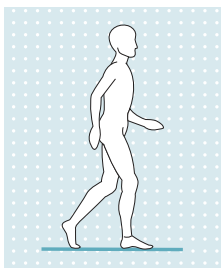

For running over longer periods of time, the "Running" MyMode which can be activated using the Cockpit app or a movement pattern can be configured using the adjustment software.

In this mode, every step will be performed as a running step with larger swing phase angle and no preflexion at heel strike (PreFlex) (see page 41).

#### INFORMATION

The running function will work with specialised running feet such as the 1E95 Challenger as well as with prosthetic feet with axial compression such as the 1C61 Triton Vertical Shock. For details on assembly and alignment please refer to the instructions for use of the foot.

Feet without axial compression are generally not suited for running.

## 10.2 Switching MyModes with the cockpit app

### INFORMATION

Bluetooth on the prosthesis must be turned on in order to use the Cockpit app.

If Bluetooth is switched off, it can be turned on by turning the prosthesis upside-down (function only available in basic mode) or by connecting/disconnecting the battery charger. Bluetooth is then turned on for approx. 2 minutes. During this time, the app must be started and used to establish a connection. If required, Bluetooth on the prosthesis can be switched on permanently afterwards (see page 40).

### INFORMATION

If the **Volume** parameter is set to '0' in the Cockpit app (see page 37) or if mute mode (silent mode) is activated, there are no beep signals.

Once a connection to a prosthesis has been established, the cockpit app can be used to switch between the MyModes.

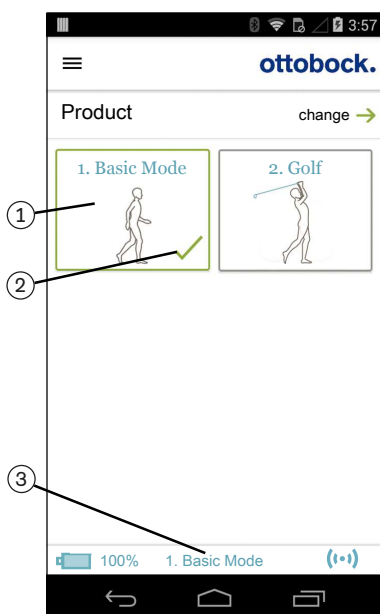

- 1) Tap the symbol of the MyMode (1) you want in the main menu of the app.  
→ A security question for changing the MyMode appears.
- 2) If you want to change the mode, tap the "OK" button.  
→ A beep signal sounds to confirm the switch.
- 3) After switching, a symbol (2) is displayed to identify the active mode.  
→ The current mode is also indicated by the name on the lower edge of the screen (3).

## 10.3 Switching MyModes using motion patterns

### INFORMATION

When mute mode (silent mode) is activated, no beep and vibration signals are generated.

### INFORMATION

If the **Volume** parameter is set to '0' in the Cockpit app (see page 37) or if mute mode (silent mode) is activated, there are no beep signals.

### Information on switching

- Switching and the number of motion patterns must be activated in the adjustment software.
- Before the first step, always check whether the selected mode corresponds to the required motion type.

### Requirements for successful switching using motion patterns

The following points must be observed to carry out switching successfully:

- Switching using motion patterns has to be enabled in the adjustment software.
- Position the prosthetic leg back slightly and bounce on the forefoot with the leg extended while maintaining constant contact with the floor.
- Weight must be placed on the forefoot while bouncing.
- Do not take the weight off fully during unloading while bouncing.

**Switching process**

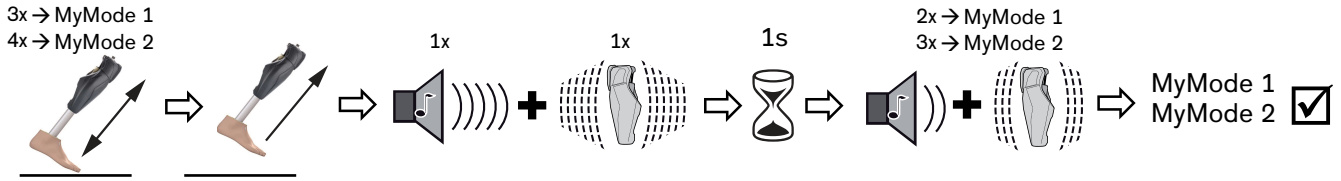

- 1) Position the prosthetic leg slightly to the rear (step position).
- 2) While maintaining constant contact with the floor, bounce on the forefoot with the leg extended a number of times in one second depending on the desired MyMode (MyMode 1 = 3 times, MyMode 2 = 4 times).
- 3) Fully unload and keep the prosthetic leg still in this position (step position).
  - A beep and vibration signal will sound to confirm that the movement pattern has been recognised.
  - INFORMATION: If this beep and vibration signal does not sound, the requirements were not observed when bouncing the foot or mute mode (silent mode) is activated. For more information about mute mode, see the section "Mute mode" (see page 41).**
- 4) After the beep and vibration signal sounds, keep the prosthetic leg extended and still for 1 second.
  - A confirmation signal will sound to indicate that the prosthesis has successfully switched to the corresponding MyMode (2 times = MyMode 1, 3 times = MyMode 2).
  - INFORMATION: If this confirmation signal does not sound, the leg with the prosthesis was not correctly kept still or mute mode (silent mode) is activated. Repeat the process for correct switching. For more information about mute mode, see the section "Mute mode" (see page 41).**

**10.4 Switching from a MyMode back to basic mode**

**Information on switching**

- Regardless of the configuration of additional MyModes in the adjustment software, it is always possible to switch back to basic mode (mode 1) with a motion pattern.
- It is always possible to switch back to basic mode (mode 1) by connecting/disconnecting the battery charger.
- Before the first step, always check whether the selected mode corresponds to the required motion type.

**Requirements for successful switching using motion patterns**

The following points must be observed to carry out switching successfully:

- Position the prosthetic leg back slightly and bounce on the forefoot with the leg extended while maintaining constant contact with the floor.
- Weight must be placed on the forefoot while bouncing.
- Do not take the weight off fully during unloading while bouncing.

**Switching process**

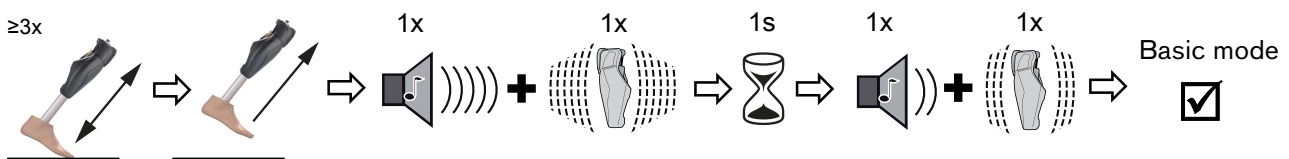

- 1) Position the prosthetic leg slightly to the rear (step position).
- 2) While maintaining constant contact with the floor, and with the leg extended, bounce on the forefoot three or more times.
- 3) Fully unload and keep the prosthetic leg still in this position (step position).
  - A beep and vibration signal will sound to confirm that the movement pattern has been recognised.
  - INFORMATION: If this beep and vibration signal does not sound, the requirements were not observed when bouncing the foot or mute mode (silent mode) is activated. For more information about mute mode, see the section "Mute mode" (see page 41).**
- 4) After the beep and vibration signal sounds, keep the prosthetic leg extended and still for 1 second.

→ A confirmation signal will sound to indicate that the prosthesis has successfully switched over to basic mode.

**INFORMATION: If this confirmation signal does not sound, the leg with the prosthesis was not correctly kept still or mute mode (silent mode) is activated. Repeat the process for correct switching. For more information about mute mode, see the section "Mute mode" (see page 41).**

## 11 Additional operating states (modes)

### 11.1 Empty battery mode

Beeps and vibration signals are emitted if the available battery charge level is 5% (see page 52). During this time, damping settings are set to their safety mode values. This may be low or high depending on the setting in the adjustment software. The prosthesis is then switched off. You can switch back to basic mode (mode 1) from empty battery mode by charging the product.

### 11.2 Mode for charging the prosthesis

The product is non-functional during charging.

The product is set to the safety mode resistance values. These may be low or high depending on the setting in the adjustment software.

### 11.3 Safety mode

The product automatically switches to safety mode if a critical fault occurs (e.g. failure of a sensor signal). Safety mode remains in effect until the error has been rectified.

The switch to safety mode is indicated by beeps and vibration signals immediately prior to switching (see page 52). Safety mode can be disabled by connecting and disconnecting the battery charger. If the product switches into safety mode again, this means a permanent error exists. The product must be inspected by an authorised Ottobock Service Centre.

Depending on the type and severity of the error, different remaining functionality is offered in safety mode. This makes limited walking possible for the user depending on the type of error.

#### The following functionality is available:

- **Moderate error:** Continuous stance phase flexion resistance is set, with the ability to initiate the swing phase. The swing phase control and stance phase extension resistance may be available or not depending on the type of error.
- **Severe error:** Safety mode flexion resistance is configured. This may be low or high depending on the setting in the adjustment software. Depending on the type of error, the product may also be blocked entirely in the flexion direction.

#### The following functions are deactivated in safety mode:

- OPG function
- Stairs and obstacles function
- Stance function
- Sitting function

### 11.4 Overheating mode

#### INFORMATION

When mute mode (silent mode) is activated, no beep and vibration signals are generated.

When the hydraulic unit overheats due to uninterrupted, increased activity (e.g. extended walking downhill), the flexion resistance is increased along with the rising temperature in order to counteract the overheating. When the hydraulic unit cools down, the product switches back to the settings that existed prior to overheating mode.

Overheating mode is not activated in the MyModes.

Overheating mode is indicated by a long vibration every 5 seconds.

#### The following functions are deactivated in overheating mode:

- Sitting function
- Display of the battery charge level without additional equipment
- Switching to a MyMode

## 12 Storage and bleeding

Air may accumulate in the hydraulic unit if the product is stored for longer periods and not in an upright position. This is noticeable through sounds and irregular damping behaviour.

The automatic bleeding mechanism ensures that all functions of the product are again intact after approximately 10 - 20 steps.

### Storage

- Before storing the knee joint, the knee head has to be extended. The knee head must not be flexed!
- Avoid extended disuse of the product (use the product regularly).

## 13 Cleaning

- 1) Rinse the product with clear fresh water.
- 2) Dry the product with a soft cloth.
- 3) Allow to air dry in order to remove residual moisture.

### INFORMATION

Please note that the weight of dirt adhering to the prosthesis can affect the gait pattern.

## 14 Maintenance

Regular maintenance (service inspections) at 12-month intervals is mandatory in the interest of patient safety and in order to maintain operating reliability and protect the warranty, maintain basic safety and the essential performance characteristics, and ensure safety in regards to EMC.

When maintenance is due, this is indicated by feedback after disconnecting the battery charger (see the section "Operating states/error signals", see page 51).

Additional services such as repairs may be provided in the course of maintenance. These additional services may be provided free of charge or can be billable according to an advance cost estimate, depending on the extent and validity of the warranty.

The following components must always be sent in for maintenance and repairs:

The product with installed tube adapter, battery charger and power supply unit. The shipping container for the loaner unit you receive must be reused for sending back the components requiring inspection.

Before shipping, the knee head of the prosthetic knee joint has to be extended. The knee head must not be flexed!

### 14.1 Identification of the product by the Service Center

The product may have been identified by an authorised Ottobock Service Center:



#### Factory setting

The patient-specific product settings have been reset to the state at delivery (factory setting).



#### User setting

The settings already configured using the adjustment software were not changed.

### CAUTION

#### Use of the prosthesis with incorrect setting data

Falling due to unexpected prosthesis behaviour caused by triggering the swing phase at the wrong time.

- ▶ The prosthesis settings (parameters) have to be checked using the corresponding adjustment software and changed as needed.

## 15 Legal information

All legal conditions are subject to the respective national laws of the country of use and may vary accordingly.

## 15.1 Liability

The manufacturer will only assume liability if the product is used in accordance with the descriptions and instructions provided in this document. The manufacturer will not assume liability for damage caused by disregarding the information in this document, particularly due to improper use or unauthorised modification of the product.

## 15.2 Trademarks

All product names mentioned in this document are subject without restriction to the respective applicable trademark laws and are the property of the respective owners.

All brands, trade names or company names may be registered trademarks and are the property of the respective owners.

Should trademarks used in this document fail to be explicitly identified as such, this does not justify the conclusion that the denotation in question is free of third-party rights.

## 15.3 CE conformity

Otto Bock Healthcare Products GmbH hereby declares that the product is in compliance with applicable European requirements for medical devices.

The product meets the requirements of the RoHS Directive 2011/65/EU on the restriction of the use of certain hazardous substances in electrical and electronic devices.

This product meets the requirements of the 2014/53/EU directive.

The full text of the regulations and requirements is available at the following Internet address: <http://www.ottobock.com/conformity>

## 15.4 Local Legal Information

Legal information that applies **exclusively** to specific countries is written in the official language of the respective country of use in this chapter.

This device complies with part 15 of the FCC Rules. Operation is subject to the following two conditions:

- 1) This device may not cause harmful interference, and
- 2) This device must accept any interference received, including interference that may cause undesired operation.

This equipment has been tested and found to comply with the limits for a Class B digital device, pursuant to part 15 of the FCC Rules. These limits are designed to provide reasonable protection against harmful interference in a residential installation. This equipment generates uses and can radiate radio frequency energy and, if not installed and used in accordance with the instructions, may cause harmful interference to radio communications. However, there is no guarantee that interference will not occur in a particular installation. If this equipment does cause harmful interference to radio or television reception, which can be determined by turning the equipment off and on, the user is encouraged to try to correct the interference by one or more of the following measures:

- Reorient or relocate the receiving antenna.
- Increase the separation between the equipment and receiver.
- Connect the equipment into an outlet on a circuit different from that to which the receiver is connected.
- Consult the dealer or an experienced radio/ TV technician for help.

Any changes or modifications not expressly approved by the party responsible for compliance could void the user's authority to operate the equipment.

### **Caution: Exposure to Radio Frequency Radiation.**

This device must not be co-located or operating in conjunction with any other antenna or transmitter.

This device contains licence-exempt transmitter(s)/receiver(s) that comply with Innovation, Science and Economic Development Canada's licence-exempt RSS(s)..

Operation is subject to the following two conditions:

- (1) This device may not cause interference.
- (2) This device must accept any interference, including interference that may cause undesired operation of the device.

L'émetteur/récepteur exempt de licence contenu dans le présent appareil est conforme aux CNR d'Innovation, Sciences et Développement économique Canada applicables aux appareils radio exempts de licence. L'exploitation est autorisée aux deux conditions suivantes:

- (1) L'appareil ne doit pas produire de brouillage;
- (2) L'appareil doit accepter tout brouillage radioélectrique subi, même si le brouillage est susceptible d'en compromettre le fonctionnement.



**Caution: Exposure to Radio Frequency Radiation.**

The installer of this radio equipment must ensure that the antenna is located or pointed such that it does not emit RF field in excess of Health Canada limits for the general population.

**Caution: Federal law (USA) restricts this device to sale by or on the order of a practitioner licensed by law of the State in which he/she practices to use or order the use of the device.**

## 16 Technical data

<b>Ambient conditions</b>	
Transport in original packaging	-25 °C/-13 °F to +70 °C/+158 °F
Storage in the original packaging (≤3 months)	-20 °C/-4 °F to +40 °C/+104 °F Max. 93% relative humidity, non-condensing
Long-term storage in the original packaging (>3 months)	-20 °C/-4 °F to +20 °C/+68 °F Max. 93% relative humidity, non-condensing
Transport and storage between applications (without packaging)	-25 °C/-13 °F to +70 °C/158 °F Max. 93% relative humidity, non-condensing
Operation	-10 °C/+14 °F to +60 °C/+140 °F Max. 93% relative humidity, non-condensing
Time for warming to the operating temperature after storage between applications, from -25 °C/-13 °F at an ambient temperature of +20 °C/+68 °F	30 minutes
Time for cooling to the operating temperature after storage between applications, from +70 °C/+158 °F at an ambient temperature of +20 °C/+68 °F	30 minutes
Charging the battery	+10 °C/+50 °F to +45 °C/+113 °F
<b>Product</b>	
Reference number	3B5-3*/3B5-3=ST*
Mobility grade (MOBIS)	3 and 4
Maximum body weight including additional weight	150 kg
Protection rating	IP66/IP68 Maximum water depth: 3 m Maximum time: 1 hour
Water resistance	Waterproof, corrosion-resistant, resistant to penetration from jets of water
Prox. system height to alignment reference point 3B5-3* (pyramid)	0 mm
Proximal system height up to alignment reference point 3B5-3=ST* (threaded connector)	26 mm
Minimum knee pivot point to ground measurement when using 2R19 and 1C63	359 mm
Minimum distal system height with 2R19 tube adapter	299 mm
Maximum distal system height with 2R19 tube adapter	514 mm
Range of Bluetooth connection to PC	Max. 10 m
Range of Bluetooth connection to mobile device	Max. 10 m
Maximum possible flexion angle	135°
Maximum possible flexion angle with preinstalled 4H104* flexion stop	112.5°
Maximum possible flexion angle with 4H101 flexion stop	127.5°
Maximum possible flexion angle with 4H102 flexion stop	120°
Maximum insertion depth of the tube adapter in the knee joint	70 mm
Weight of the prosthesis without tube adapter, with Protective Cover	Approx. 1700 g



<b>Product</b>	
Information on the product's ruleset and firmware version	Accessible via the Cockpit app navigation menu and the menu item <b>"Imprint/Info"</b>
Expected lifetime if prescribed maintenance intervals are complied with	6 years
Test procedure	ISO 10328-P6-150 kg / 3 million load cycles
<b>Data transfer</b>	
Wireless technology	Bluetooth Smart Ready
Range	approx. 10 m / 32.8 ft
Frequency range	2402 MHz to 2480 MHz
Modulation	GFSK, $\pi/4$ DQPSK, 8DPSK
Data rate (over the air)	2178 kbps (asymmetrical)
Maximum output power (EIRP):	+8.5 dBm
<b>Tube adapter</b>	
Reference number	2R19
Weight	190 g–300 g
Material	Aluminium
Max. body weight	150 kg
Protection rating	IP66/IP68 Maximum water depth: 3 m Maximum time: 1 hour
Water resistance	Waterproof, corrosion-resistant, resistant to penetration from jets of water
Lifetime	6 years
<b>Prosthesis battery</b>	
Battery type	Li-Ion
Charging cycles (charging and discharging cycles) after which at least 80% of the original battery capacity remains available	500
Charge level after 1 hour charging time	30 %
Charge level after 2 hours charging time	50 %
Charge level after 4 hours charging time	80 %
Charge level after 8 hours charging time	Fully charged
Product behaviour during the charging process	The product is non-functional
Operating time of the prosthesis with new, fully charged battery at room temperature	Approx. 5 days with average use
<b>Power supply unit</b>	
Reference number	757L16-4
Type	FW8001M/12
Storage and transport in original packaging	-40 °C/-40 °F to +70 °C/+158 °F 10% to 95% relative humidity, non-condensing
Storage and transport without packaging	-40 °C/-40 °F to +70 °C/+158 °F 10% to 95% relative humidity, non-condensing
Operation	0 °C/+32 °F to +50 °C/+122 °F Max. 95% relative humidity Air pressure: 70–106 kPa (up to 3,000 m without pressure equalisation)
Input voltage	100 V~ to 240 V~
Mains frequency	50 Hz to 60 Hz
Output voltage	12 V $\equiv$
<b>Battery charger</b>	
Reference number	4E60*

<b>Battery charger</b>	
Storage and transport in original packaging	-25 °C to 70 °C/-13 °F to 158 °F
Storage and transport without packaging	-25 °C to 70 °C/-13 °F to 158 °F Max. 93% relative humidity, non-condensing
Operation	5 °C to 40 °C/41 °F to 104 °F Max. 93% relative humidity, non-condensing
Protection rating	IP40
Input voltage	12 V $\overline{=}$
Wireless technology	Proprietary protocol
Frequency range	270 kHz to 450 kHz
Modulation	ASK, load modulation
Maximum output power (EIRP)	-12.7 dB $\mu$ A/m @ 10 m

<b>Cockpit app</b>	
Reference number	4X441-V2=IOS Cockpit/4X441-V2=ANDR Cockpit
Version	Version 2.5.0 or higher
Supported operating system	See the information in the respective online store (e.g. Apple App Store, Google Play Store, etc.) regarding compatibility with mobile devices and versions.
Website for download	<a href="https://www.ottobock.com/cockpitapp">https://www.ottobock.com/cockpitapp</a>





**Torque values of the screw connections**

Using a torque wrench, tighten the corresponding screws alternately in several cycles until the specified tightening torque is reached.

<b>Screw connection</b>	<b>Tightening torque</b>
Tube adapter on prosthetic foot	15 Nm / 133 lbf. In.
Tube clamp of the knee joint	7 Nm / 62 lbf. In.
Proximal prosthesis components with pyramid receiver	15 Nm / 133 lbf. In.
Proximal prosthesis components with threaded connector	10 Nm / 89 lbf. In.
Flexion stop	1 Nm / 5 lbf. In.

**17 Appendices**

**17.1 Symbols Used**

-  Manufacturer
-  Type BF applied part
-  Compliance with the requirements according to "FCC Part 15" (USA)
-  Compliance with the requirements under the "Radiocommunications Act" (AUS)
-  Non-ionising radiation
- IP40** Protection against penetration of solid foreign objects with a diameter greater than 1 mm, no protection against water

**IP66** Dust-proof, protected against strong jets of water

**IP68** Dustproof, protection against permanent submersion.  
Maximum depth: 3 m  
Maximum time: 1 hour



In some jurisdictions it is not permissible to dispose of these products with unsorted household waste. Disposal that is not in accordance with the regulations of your country may have a detrimental impact on health and the environment. Please observe the instructions of your national authority pertaining to return and collection.

**DUAL** The product's Bluetooth wireless module can establish a connection to mobile devices with the following operating systems: iOS (iPhone, iPad, iPod...) and Android

**CE** Declaration of conformity according to the applicable European directives



Serial number (YYYY WW NNN)  
YYYY – year of manufacture  
WW – week of manufacture  
NNN – sequential number



Lot number (PPPP YYYY WW)  
PPPP – plant  
YYYY – year of manufacture  
WW – week of manufacture



Article number



Medical device



Caution, hot surface



Protect from moisture



Please note the instructions for use



Check the product settings using the corresponding adjustment software of the Ottobock Data Station.

## 17.2 Operating states/error signals

The prosthesis indicates operating states and error messages through beeps and vibration signals.

### 17.2.1 Signals for operating states

#### Battery charger connected/disconnected

Beep signal	Vibration signal	Event
—	3x long	Charging mode started (3 sec. after connecting the battery charger)
1x short	1x short	Self-test completed successfully, product is operational

## Mode switching

### INFORMATION

When mute mode (silent mode) is activated, no beep and vibration signals are generated.

### INFORMATION

If the **Volume** parameter is set to '0' in the Cockpit app, there are no beep signals (see page 37).

Beep signal	Vibration signal	Additional action performed	Event
1x short	1x short	Mode switching using the Cockpit app	Mode switching is performed using the Cockpit app.
1x long	1x long	Bouncing on the forefoot followed by unloading the prosthetic leg	Bouncing pattern recognised.
1x short	1x short	Weight taken off prosthetic leg and leg kept still for 1 second	Switching to basic mode (mode 1) carried out.
2x short	2x short	Weight taken off prosthetic leg and leg kept still for 1 second	Switching to MyMode 1 (mode 2) carried out.
3x short	3x short	Weight taken off prosthetic leg and leg kept still for 1 second	Switching to MyMode 2 (mode 3) carried out.

## 17.2.2 Warnings/error signals



### Error during use

Beep signal	Vibration signal	Result	Required action
–	1 x long at intervals of approx. 5 seconds (if mute mode (silent mode) is activated, this signal is not generated)	Overheated hydraulic unit	Reduce activity.
–	3 x long	Charge level under 25%	Charge battery soon. Remaining operating time approx. 24 hours
–	5 x long	Charge level under 10%	Charge battery soon. Remaining operating time approx. 6 hours
5 x long	5 x long repeated every 60 seconds	<b>Medium error (see page 45)</b> e.g. a sensor is not operational	Walking possible with restrictions. Please note the change in flexion resistance. The product must be inspected immediately by an authorised Ottobock Service Center.
10 x long	10 x long	Battery charge level 5% After the beep and vibration signals, the product switches to empty battery mode and then switches off.	Charge the battery.
30 x long	1 x long, 1 x short repeated every 3 seconds	<b>Severe error/indication of safety mode activation (see page 45)</b> e.g. one or more sensors are not operational.	Attempt to reset this error by connecting/disconnecting the battery charger. If the error persists, use of the product is prohibited. The product must be inspected by an authorised Ottobock Service Center.

Beep signal	Vibration signal	Result	Required action
–	Continuous	<b>Total failure</b> Electronic control no longer possible. Safety mode active or undetermined valve state. Undetermined product behaviour.	Attempt to reset this error by connecting/disconnecting the battery charger. If the error persists, use of the product is prohibited. The product must be inspected by an authorised Ottobock Service Center.

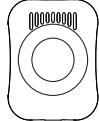
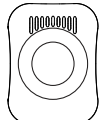
**Error while charging the product**

LED on power supply	Status LED on battery charger	Error	Resolution
○		Country-specific plug adapter not fully engaged on power supply	Check whether the country-specific plug adapter is fully engaged on the power supply.
		Non-functional socket	Check socket with another electric appliance.
		Defective power supply	The battery charger and power supply must be inspected by an authorised Ottobock Service Centre.
●		No connection between battery charger and power supply	Check whether the charging cable plug is fully engaged on the battery charger.
		Defective battery charger	The battery charger and power supply must be inspected by an authorised Ottobock Service Centre.

	Status LED	Charging status indicator (5 LEDs)	Error	Resolution
	The LED ring is lit in weak purple	No LED is lit	Distance between battery charger and receiver of the charging unit on the prosthesis too great. If the distance is more than 2 mm, the prosthesis cannot be charged.	Reduce distance between battery charger and receiver of the charging unit.
	The LED ring is lit up yellow	LED 2 and 4 are lit up	Charger excess temperature	Check whether the specified ambient conditions for charging the battery are met (see page 48).
		LED 1, 3 and 5 are lit up	Excessively high or low temperature of the prosthesis	
		LED 3 is lit up	The prosthesis is not being charged Distance between battery charger and receiver of the charging unit too great.	Connection may be improved by reducing the distance between the charger and receiver of the charging unit.
	The LED ring is lit up green		The battery charger is functional but not connected to the receiver, or the distance between the battery charger and receiver of the charging unit is too great.	Connect the battery charger or reduce the distance between the charger and the receiver of the charging unit on the prosthesis.

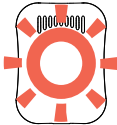

	Status LED	Charging status indicator (5 LEDs)	Error	Resolution
	The LED ring is flashing red		The prosthesis is not being charged Defective battery charger.	Reset the error by disconnecting and connecting the power supply. If the error persists, the battery charger and power supply must be inspected by an authorised Ottobock Service Center.

### 17.2.3 Error messages while establishing a connection with the cockpit app

Error message	Cause	Correction
<b>Component was connected to another device. Establish connection?</b>	The component was connected to another device	To disconnect the original connection, tap the "OK" button. If the original connection is not to be disconnected, tap the "Cancel" button.
<b>Mode change failed</b>	An attempt was made to switch to a different MyMode while the component was in motion (e. g. while walking)	For safety reasons, switching MyModes is only permitted when components are at rest, e. g. while standing or sitting.
	A current connection to the component was interrupted	Check the following points: <ul style="list-style-type: none"> <li>• Distance from the component to the device</li> <li>• Charge level of the component's battery</li> <li>• Bluetooth of the component switched on? (Switching Bluetooth of the component on/off)</li> <li>• Hold the component with the sole of the foot facing up to make the component "visible" for 2 minutes.</li> <li>• If multiple components were stored, was the correct component selected?</li> </ul>

### 17.2.4 Status signals

#### Battery charger connected

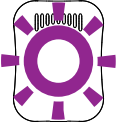
LED on power supply	Status LED on battery charger	Event
		Power supply and battery charger operational. Battery charger not yet connected to receiver.
		Battery charger connected to receiver, good connection. This display turns off automatically after approximately one minute to avoid bothersome light at night. The charging process is not affected.

#### Battery charger disconnected

Beep signal	Vibration signal	Event	Resolution
1x short	1x short	Self-test completed successfully. Product is operational.	

Beep signal	Vibration signal	Event	Resolution
3x short	3x short	Maintenance note: E.g.: Maintenance interval has been exceeded, temporary disruption of a sensor signal	<ul style="list-style-type: none"> <li>Use the Cockpit app to check the next maintenance date for the prosthesis (see page 40). If the date has been reached or exceeded, the prosthesis and tube adapter, battery charger and power supply have to be sent to an authorised Ottobock Service Center.</li> <li>Conduct the self-test again by connecting/disconnecting the battery charger.</li> <li>If the beep is emitted again and the maintenance date has not been reached or exceeded, the prosthesis should be inspected by an authorised Ottobock Service Center.</li> <li>The product can be used without restrictions. However, vibration signals may not be generated.</li> </ul>
5x long	5x long (every minute)	AXON tube adapter not connected while removing inductive charger	<ul style="list-style-type: none"> <li>Connect the AXON tube adapter and then restart the knee joint by connecting/disconnecting the battery charger</li> <li>If the beep/vibration signal recurs, the product must be inspected by an authorised Ottobock Service Center.</li> </ul>

### Battery charge level

During the charging process, the current battery charge level is indicated by the number of LEDs lit on the side of the charger.

LEDs	0	1	2	3	4	5
Battery charge level	0%-10%	10%-30%	30%-50%	50%-70%	70%-90%	>90%

## 17.3 Directives and manufacturer's declaration

### 17.3.1 Electromagnetic environment

This product is designed for operation in the following electromagnetic environments:

- Operation in a professional healthcare facility (e.g. hospital, etc.)
- Operation in areas of home healthcare (e.g. use at home, use outdoors)

Observe the safety notices in the section "Information on proximity to certain areas" (see page 19).

### Electromagnetic emissions

Interference measurements	Compliance	Electromagnetic environment directive
HF emissions according to CISPR 11	Group 1/class B	The product uses HF energy exclusively for its internal functioning. Its HF emissions are therefore very low, and interference with neighbouring electronic devices is unlikely.
Harmonics according to IEC 61000-3-2	Not applicable – power below 75 W	–
Voltage fluctuations/flicker according to IEC 61000-3-3	Product meets the requirements of the standard.	–

**Electromagnetic interference immunity**

Phenomenon	EMC basic standard or test procedure	Interference immunity test level
Electrostatic discharge	IEC 61000-4-2	± 8 kV contact ± 2 kV, ± 4 kV, ± 8 kV, ± 15 kV air,
High-frequency electro-magnetic fields	IEC 61000-4-3	10 V/m 80 MHz to 2.7 GHz 80% AM at 1 kHz
Magnetic fields with rated power frequencies	IEC 61000-4-8	30 A/m 50 Hz or 60 Hz
Electrical fast transients/bursts	IEC 61000-4-4	± 2 kV 100 kHz repetition rate
Surges Line against line	IEC 61000-4-5	± 0.5 kV, ± 1 kV
Conducted interference induced by high-frequency fields	IEC 61000-4-6	3 V 0.15 MHz to 80 MHz 6 V in ISM and amateur frequency bands between 0.15 MHz and 80 MHz 80% AM at 1 kHz
Voltage drops	IEC 61000-4-11	0% U <sub>T</sub> ; 1/2 period At 0, 45, 90, 135, 180, 225, 270 and 315 degrees 0% U <sub>T</sub> ; 1 period and 70% U <sub>T</sub> ; 25/30 periods Single phase: at 0 degrees
Voltage interruptions	IEC 61000-4-11	0% U <sub>T</sub> ; 250/300 periods

**Interference resistance against wireless communication devices**

Test frequency [MHz]	Frequency band [MHz]	Radio service	Modulation	Maximum power [W]	Distance [m]	Interference immunity test level [V/m]
385	380 to 390	TETRA 400	Pulse modulation 18 Hz	1.8	0.3	27
450	430 to 470	GMRS 460, FRS 460	FM ± 5 kHz deviation 1 kHz sine	1.8	0.3	28
710	704 to 787	LTE band 13, 17	Pulse modulation 217 Hz	0.2	0.3	9
745						
780						
810	800 to 960	GSM 800/900, TETRA 800, iDEN 820, CDMA 850, GSM 800/900, LTE band 5	Pulse modulation 18 Hz	2	0.3	28
870						
930						



Test frequency [MHz]	Frequency band [MHz]	Radio service	Modulation	Maximum power [W]	Distance [m]	Interference immunity test level [V/m]
1,720	1,700 to 1,990	GSM 1800; CDMA 1900; GSM 1900; DECT; LTE band 1, 3, 4, 25; UMTS	Pulse modulation 217 Hz	2	0.3	28
1,845						
1,970						
2,450	2,400 to 2,570	Bluetooth WLAN 802.11- b/g/n, RFID 2450 LTE band 7	Pulse modulation 217 Hz	2	0.3	28
5,240	5,100 to 5,800	WLAN 802.11- a/n	Pulse modulation 217 Hz	0.2	0.3	9
5,500						
5,785						



A series of horizontal lines for writing, spanning the width of the page.



A series of horizontal lines for writing, spanning the width of the page.

**The product 3B5-3/3B5-3=ST is covered by the following patents:**

Canada: CA 2 651 124; CA 2 714 469; CA 2 780 511; CA 2 704 792; CA 2 626 738; CA 2 780 192; CA 2 779 784  
China: CN 101 453 963; CN 101 909 553; CN 101 938 958; CN 102 711 672; CN 102 647 963; CN 101 346 110;  
CN 102 740 804; CN 102 762 171; CN 102 724 936; CN 102 740 803; CN 104 856 787  
Finland: FI 110 159  
Germany: DE 10 2008 010 281; DE 10 2009 052 887  
Japan: JP 4 718 635; JP 5 619 910; JP 5 547 091; JP 5 394 579; JP 5 968 591; JP 5 678 079; JP 6 109 793;  
Russia: RU 2 404 730; RU 2 484 789; RU 2 533 967; RU 2 488 367; RU 2 508 078; RU2 572 741  
Taiwan: R.O.C. Invention Patent No. I386194; I459936; I442912; I494095; I551277; I551278; 530278; I542335; I519292;  
I517845  
USA: US 7 731 759; US 6 908 488; US 8 083 807, US 8 474 329; US 8 876 912; US 8 814 948; US 9 066 818;  
US 9 278 013; US 9 248 031; US 9 572 690  
European Patent EP 1237513 in DE, FR, GB  
EP 2015712 in DE, ES, FR, GB, IT, NL, SE, TR  
EP 2240124 in DE, FR, GB, IT, NL, SE, TR  
EP 2498724 in DE, FR, GB, IS, IT, NL, SE, TR  
EP 2498725 in DE, FR, GB  
EP 2498726 in DE, FR, GB, IS, IT, NL, SE, TR  
EP 2498727 in DE, FR, GB, IS, IT, NL, SE, TR  
EP 2498729 in DE, FR, GB  
EP 2498730 in DE, FR, GB  
EP 2498728 in DE, FR, GB  
EP 2254525 in DE, FR, GB, IS, IT, NL, TR  
EP 2222253 in DE, FR, GB, IS, IT, NL, SE, TR  
EP 1940327 in DE, FR, GB, IS, IT, NL, SE, TR  
EP 2772232 in DE, GB, FR, IT, NL, SE, TR, IS

Patents pending in Brazil, Germany and USA



Otto Bock Healthcare Products GmbH  
Brehmstraße 16 · 1110 Wien · Austria  
T +43-1 523 37 86 · F +43-1 523 22 64  
info.austria@ottobock.com · www.ottobock.com